

5th Colorado Edition

Price: \$3.00



Where *Custom* Has No Limits ...



BUG  
GHIA  
TYPE III  
THING  
TYPE 34





## **KNEBES INTERIOR**

We occasionally name a Seat Cover Style, a Panel, or a Complete Interior after the first customer who ordered it. Because it is distinctly unique, the name associated with the interior immediately identifies all the sewing details to all of our staff...no detailed explanations required in the manufacturing process. The KNEBES INTERIOR is legendary to Sewfine, and remains one of our most popular styles. The Interior is sewn with Black Vinyl, but can be made in any color Vinyl. It is a 1 Color Interior, mainly defined by Contrasting Stitching and French Seams.



**CONTRASTING THREAD:** The Knebes interior is sewn with heavy red contrast thread, but others are available – Black, Lt. Gray, Orange, Yellow, Brown, Sand, "Tie-Dye" Multicolor and Blue.

**KNEBES SEAT COVERS** have Red Heavy Contrast Thread through the Pleat Lines, as well as on the French Seam Edging detail. Available on Low Back Seat Covers only. Add \$450 to the price of Standard insert Seat Covers on pages 12-13.

**KNEBES DOOR PANELS** have Red Heavy Contrast Thread through the Pleat Lines, plus 2 French Seams on the panels. Add \$150 to the price of 58-59 Style Door panels on page 25, Style A for Bugs. For Ghia, add \$150 to 56-57 Ghia Style on page 23.

**KNEBES ARMRESTS** have Red Heavy Contrast Thread on the armrest (1956-'67 and 1973-'79 only). See Pricing on page 22.

**KNEBES HEADLINER** has Contrast Thread on each side of the seam for the listing sleeves, but creating this look requires the Headliner to actually be sewn 4 consecutive times to get all the thread sewn. Add \$375 to the normal headliner price.





## DECORATIVE STITCHING with HEAVY CONTRAST THREAD

Regular Sewing Thread is used on all Sewfine Products, but Decorative Stitching requires Different Sewing Machines, Different Thread, Different Needles, and a well-experienced skill level to create this effect, but the result is striking.

### DECORATIVE STITCHING

Can be used only on vinyl  
A single color vinyl works best



Single Pleat Line with Piping



Multicolor Thread with French Seams



French Seams

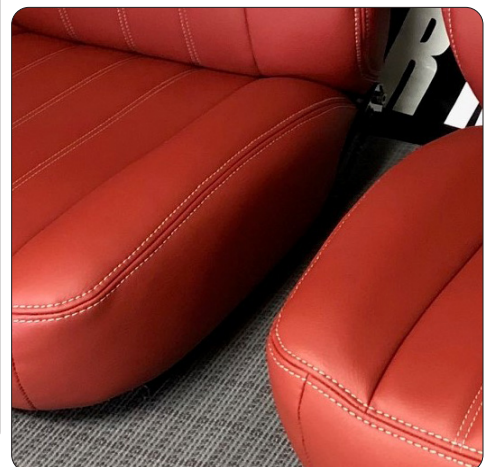

Double Needle Pleats with French Seams

**USE THIS PRICING GUIDE AS AN UPCHARGE TO ANY PRODUCT LISTED IN THE CATALOG.**

### SEAT COVERS

Single Stitch Lines through Pleats	\$75/set
Double Needle Stitch lines through Pleats	\$150/set
French Seam edging in lieu of Piping <i>(For Low Back Seats Only)</i>	\$450/set
Top Stitching in lieu of Piping <i>(For Low Back Seats Only)</i>	\$300/set

### DOOR PANELS

Single Stitch Lines through Pleats	\$75/set
Double Needle Stitch Lines through Pleats	\$100/set
Single French Seam on First or Last Pleat	\$50/set

### SUN VISORS

Single Thread Line around Perimeter	\$40/pr
-------------------------------------	---------

### AVAILABLE THREAD COLORS

- BLACK
- BROWN
- LT GREY
- SAND
- RED
- TIE-DYE
- ORANGE
- MULTI COLOR
- YELLOW
- GREEN

## DIAMOND PLEATING

### SINGLE STITCH LINES



### SINGLE NEEDLE DIAMONDS

- Add \$350 to Colorado Seats, \$350 to Rear Cover
- Add \$350 to Retro Classic Bucket Seats, \$375 to Rear Cover
- Add \$500 to Scat Procar Seats, \$375 to Rear Cover
- Add \$855 to any Full Set Seat Covers
- Add \$400 to any 4pc Door Panel Set

### DOUBLE STITCH LINES



### DOUBLE NEEDLE DIAMONDS

- Add \$450 to Colorado Seats, \$450 to Rear Cover
- Add \$450 to Retro Classic Bucket Seats, \$450 to Rear Cover
- Add \$650 to Scat Procar Seats, \$600 to Rear Cover
- Add \$1250 to any Full Set Seat Covers
- Add \$750 to any 4pc Door Panel Set



Colorado Bucket Seat with French Seams





## SCAT PROCAR LOWBACK SEATS

*Upholstered in Custom Fabrics and Custom Pleat Patterns by Sewfine Interior Products*

- Hand Sewn and Upholstered in the USA
- Mounting Brackets year specific for vehicle *(Sold separately)*
- Available in 1 or 2 Colors/Fabrics
- Includes Matching or Standard Contrast Piping

	<b>Group A</b>	<b>Group B</b>
<b>STANDARD INSERT</b>	\$1650/pr	\$1770/pr
<b>Matching Rear Seat</b>	\$320	\$390
<b>DELUXE INSERT</b>	\$1650/pr	\$1770/pr
<b>Matching Rear Seat</b>	\$350	\$420
<b>HEADRESTS</b>	\$175/pr	



**STANDARD INSERT** /// Fabric across Full Face of Seat, Xcel Sandstone, Toast Texture, Matching Piping

## RETRO CLASSIC BUCKET SEATS

- Double needle pleating
- Available in a variety of pleating and stitching patterns
- Hand Sewn and Upholstered in the USA
- Standard or Deluxe Insert
- Prices includes Sliders, Brackets Sold Separately
- French Seams Included
- Slightly bolstered for added seating support
- Optional Headrests

	<b>Group A</b>	<b>Group B</b>
<b>STANDARD INSERT</b>	\$2500/pr	\$2700/pr
<b>Matching Rear Cover</b>	\$400	\$500
<b>DELUXE INSERT</b>	\$2500/pr	\$2700/pr
<b>Matching Rear Cover</b>	\$400	\$500
<b>HEADRESTS</b>	\$125/pr	\$150/pr
<b>DECORATIVE STITCHING</b>		
<b>Heavy Contrast Thread</b>	Add \$125/pr	

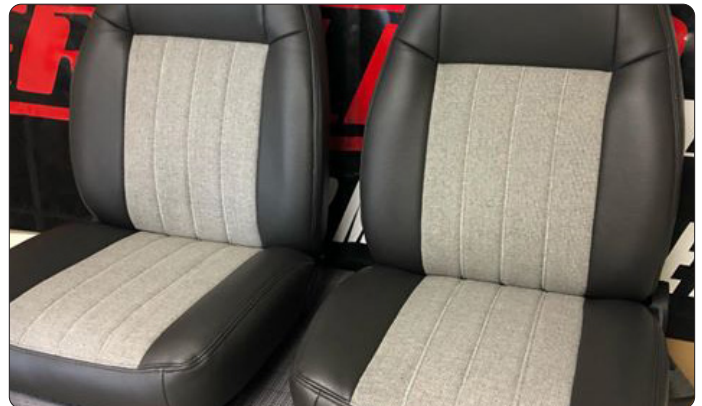

**DELUXE INSERT** /// Standard Pleating

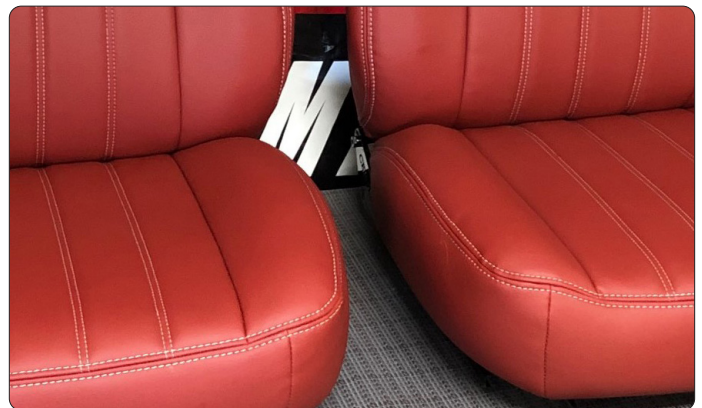

**STANDARD INSERT** /// Double Needle Pleating French Seams, Heavy Contrast Thread



### SCAT PROCAR SEAT COVERS ONLY

Includes 2 Front Bucket Covers  
 and Matching Rear Seat Cover

	Group A	Group B
<b>STANDARD INSERT</b>	\$675	\$795
<b>DELUXE INSERT</b>	\$745	\$895

#### MOUNTING BRACKETS

BUG	\$170pr
GHIA 1958-'69½: 20" between seat rails 1969½-'74: 18" between seat rails	\$170pr
TYPE III	\$185pr

**PROCAR DELUXE** /// 12" Insert Fabric through  
 Center of Seat, Xcel Black, Red Quad, Contrast Piping

### ACCESSORIES FOR ALL SEATS

Lumbar - Manual pump \$120/ea

#### SEAT HEATERS

- 2pc Pads for Seat Bottom and Backrest
- Hi/Low/Off Switch
- Easy Plug and Play Wiring

\$110/ea

#### SEAT TRIM

\$60/pr



### COLORADO BUCKET SEAT



- Available in 1 or 2 colors
- Heavy Duty Lean Back Mechanism
- Hand Sewn and Upholstered in the USA
- Seat Fully Reclines and Forward Tilts
- Includes Headrests
- Brackets Sold Separately

	Group A	Group B
<b>STANDARD INSERT</b>	\$2500/pr	\$2700/pr
<b>Matching Rear Cover</b>	\$400	\$500
<b>DELUXE INSERT</b>	\$2700/pr	\$2700/pr
<b>Matching Rear Cover</b>	\$400	\$500



## TRIM OPTIONS for SEAT COVERS

Add Variety to make your interior YOUR WAY!!



### CONTRAST PIPING

Contrast Piping is around the Outside Seams of Seat Covers. (Full set)

Standard Colors	Add \$35
Hand Made Colors	Add \$100



### DELUXE INSERT PIPING

Contrast Piping Between Insert and Trim Pieces of Seat Covers. (Full set)

Standard Piping	Add \$175/set
Hand Made Piping	Add \$275/set



**HALF PANEL INSERTS** Shown with Optional Insert Piping. Priced Separately.

Shortened Seat Bottom Inserts Front Buckets only.	Add \$150
--	-----------

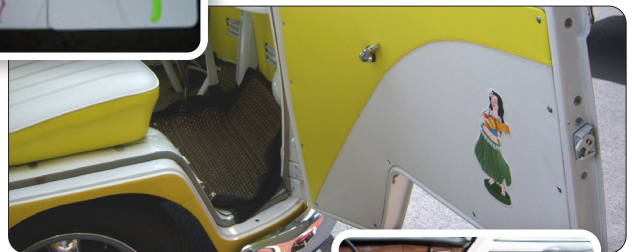
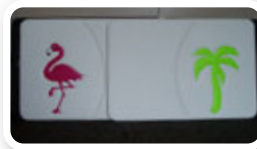

### EMBROIDERY

Prices Vary, Please call



Where *Custom* has no limits...





**1958 - '59 STYLE A DOOR PANELS** *with added Contrast Piping Lines*



**DELUXE INSERT SEAT COVERS**



**SEAFOAM CONTRAST PIPING**



PIPING IS ADDED to the **front edge** of the backrest on all the seatcovers except **HIDDEN STITCH PLEATED**, which have piping on **both front and back edges**.



# 1 SIMPLE LINE SEAT COVERS LOW BACK SEATS ONLY

- Pricing is for 1 color, Non Pleated Covers
- Pricing includes 2 Front Buckets & Matching Rear Bench
- Piping is included to match the TRIM color
- Pleated Covers have 3" Sewn Pleats with Plush Foam Backing
- Hand Made in the USA

## **BUG** SEDANS & CONVERTIBLES (2 Front Buckets & 1 Rear Bench)

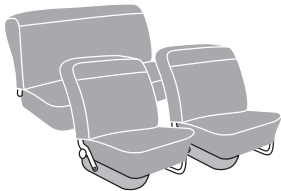

1 Color standard



1 Color pleated  
- add \$150



2 Colors - add \$80



2 Colors with pleats  
- add \$220

<b>BUG</b>	<b>Fabrics A</b>	<b>Fabrics B</b>
To-1955	\$375	\$490
1956-'57	\$375	\$490
1958-'64	\$375	\$490
1965-'67	\$390	\$490
1968-'69 Lowback Conversion	\$390	\$490
1970-'72 Lowback Conversion	\$390	\$490

The Rear Seat Cover for 1971 Bug Sedan is sewn to use with the Rear Carpet Kit "B" shown at the top of Page 41.

The Rear Seat Cover for 1972 Bug Sedan is sewn to use with the Rear Carpet Kit "C" shown at the top of Page 41.

## **TYPE III** SQUAREBACK | FASTBACK | NOTCHBACK

### **TYPE III REAR ARMREST**

1961-'72 Armrest)	Add 125
1973-'74 Armrest)	Add \$125
Armrest Rebuild	\$350

<b>NOTCHBACK   FASTBACK   SQUAREBACK</b>	<b>Fabrics A</b>	<b>Fabrics B</b>
1961-'64	\$375	\$490
1965-'67	\$390	\$490

**Center Rear  
Armrest Rebuild**





*Knapsack Vinyl Trim, Bone Tweed Inserts*

**GHIA SEDANS & CONVERTIBLES**  
 (2 Front Buckets & 1 Rear Bench)

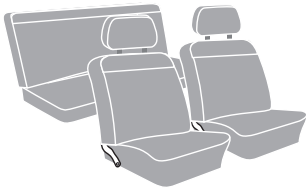

1 Color standard

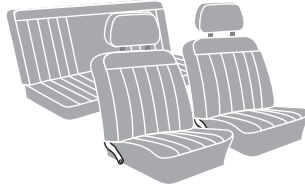

1 Color pleated  
 - add \$150



2 Colors - add \$80



2 Colors with pleats  
 - add \$220

All Years Available

**ADD INSERT PIPING** to 1 Simple Line Seat Covers

Add \$50/full set



*Black Vinyl Trim, Charcoal Vinyl Inserts  
 Double Needle Stitching  
 OMG Green Insert and Accent Piping*

**GHIA**

	<i>Fabrics A</i>	<i>Fabrics B</i>
<b>1956-'57</b> <i>Skinny Backrest</i>	\$450	\$490
<b>1958-'60</b>	\$390	\$490
<b>1961-'65</b>	\$390	\$490
<b>1966-'67</b>	\$390	\$490
<b>1969-'74</b>	\$390	\$490
<b>Headrest Covers /1969-'74</b>	\$100	\$125

**Ghia Seat Covers /1961-'68** Include Fabric to cover Seat Back Panels. *Replacement Seat Back Panels, see Page 18.*



## STANDARD INSERT SEAT COVERS

- Pricing includes 2 Front Buckets & Matching Rear Bench
- Pleated Covers have 3" Sewn Pleats with Plush Foam Backing
- Piping is included to match the TRIM color
- Hand Made in the USA

### BUG SEDANS & CONVERTIBLES (2 Front Buckets & 1 Rear Bench)

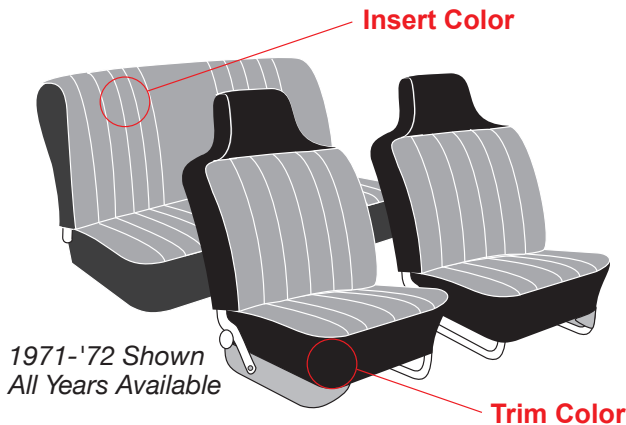

BUG	Fabrics A	Fabrics B
To-1955	\$525	\$675
1956-'57	\$525	\$675
1958-'64	\$525	\$675
1965-'67	\$525	\$675
1968-'69	\$595	\$750
1968-'69 Lowback Conversion	\$595	\$750
1970-'72	\$595	\$750
70-'72 Lowback Conversion	\$595	\$750
1973	\$595	\$750
1974-'76½	\$595	\$750
1976½ with Handwheel	\$595	\$750
1977-'79	\$595	\$675
Headrest Covers /1977-'79	\$100/pr	\$125/pr

The Rear Seat Cover for 1971 Bug Sedan is sewn to use with the Rear Carpet Kit "B" shown at the top of Page 41.

The Rear Seat Cover for 1972 Bug Sedan is sewn to use with the Rear Carpet Kit "C" shown at the top of Page 41.

### TYPE III SQUAREBACK | FASTBACK | NOTCHBACK

#### TYPE III REAR ARMREST

1961-'72 Armrest (6" from top)	Add \$125
1973-'74 Armrest (2" from top)	Add \$120
Armrest Rebuild	\$350

NOTCHBACK   FASTBACK   SQUAREBACK	Fabrics A	Fabrics B
1961-'64	\$550	\$675
1965-'67	\$550	\$670
1968-'69	\$595	\$675
1970-'72	\$595	\$675
1973-'74	\$595	\$675

#### Center Rear Armrest Rebuild





*Lt Grey Vinyl Trim, Grey Mix Tweed Inserts*



*Knapsack Ultra Vinyl, Wilderness Tweed*

***GHIA*** SEDANS & CONVERTIBLES  
 (2 Front Buckets & 1 Rear Bench)

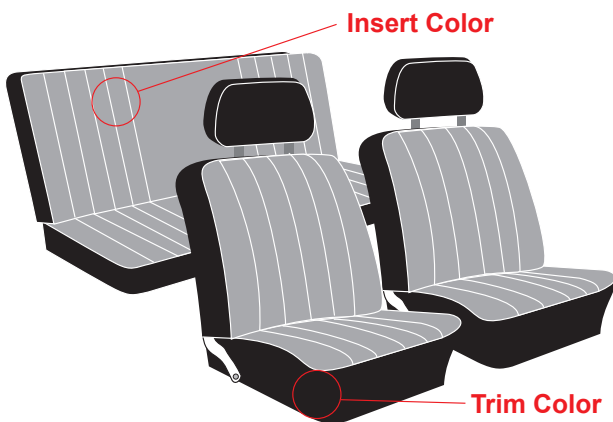

*1969-'74 Shown, All Years Available*

<b><i>GHIA</i></b>	<b><i>Fabrics A</i></b>	<b><i>Fabrics B</i></b>
<b>1956-'57</b> <i>Skinny Backrest</i>	\$675	\$780
<b>1958-'60</b>	\$570	\$680
<b>1961-'65</b>	\$570	\$680
<b>1966-'67</b>	\$570	\$680
<b>1968</b>	\$600	\$720
<b>1969-'74</b>	\$570	\$675
<b>Headrest Covers /1969-'74</b>	\$100/pr	\$125/pr

**Ghia Seat Covers /1961-'68** Include Fabric to cover Seat Back Panels. *Replacement Seat Back Panels, see Page 18.*



## DELUXE INSERT SEAT COVERS

- Pricing includes 2 Front Buckets & Matching Rear Bench
- All Covers have 3" Sewn Pleats with Plush Foam Backing

- Piping is included to match the TRIM color
- Hand Made in the USA

### BUG SEDANS & CONVERTIBLES (2 Front Buckets & 1 Rear Bench)

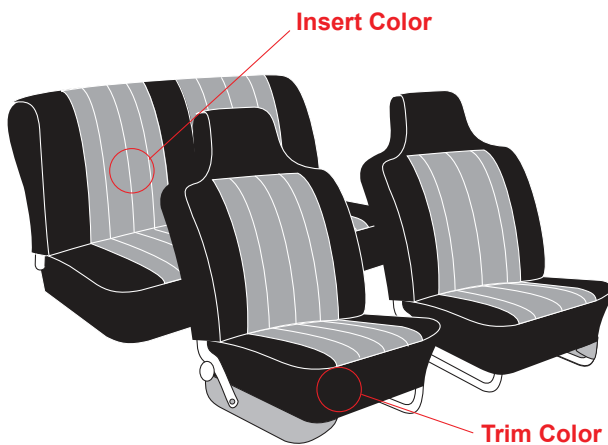

BUG	Fabrics A	Fabrics B
To-1955	\$620	\$740
1956-'57	\$600	\$720
1958-'64	\$600	\$720
1965-'67	\$600	\$720
1968-'69	\$620	\$740
1968-'69 Lowback Conversion	\$600	\$720
1970-'72	\$620	\$740
1970-'72 Lowback Conversion	\$600	\$720
1973	\$625	\$760
1974-'76½	\$650	\$760
1976½ with Handwheel	\$650	\$760
1977-'79	\$590	\$710
Headrest Covers /1977-'79	\$100	\$125

The Rear Seat Cover for 1971 Bug Sedan is sewn to use with the Rear Carpet Kit "B" shown at the top of Page 41.

The Rear Seat Cover for 1972 Bug Sedan is sewn to use with the Rear Carpet Kit "C" shown at the top of Page 41.

### TYPE III SQUAREBACK | FASTBACK | NOTCHBACK

#### TYPE III REAR ARMREST

1961-'72 Short Armrest (6" from top)	Add \$75
1973-'74 Long Armrest (2" from top)	Add \$90
Armrest Rebuild	Add \$350

NOTCHBACK   FASTBACK   SQUAREBACK	Fabrics A	Fabrics B
1961-'64	\$570	\$675
1965-'67	\$570	\$675
1968-'69	\$600	\$700
1970-'72	\$600	\$700
1973-'74	\$575	\$675

#### Center Rear Armrest Rebuild





Royal Vinyl, Brite White Vinyl  
 Royal Contrast Piping  
 Blue Squareweave Carpet



Beige Vinyl. Beige Tweed  
 Oatmeal Squareweave Carpet

**GHIA SEDANS & CONVERTIBLES**  
 (2 Front Buckets & 1 Rear Bench)

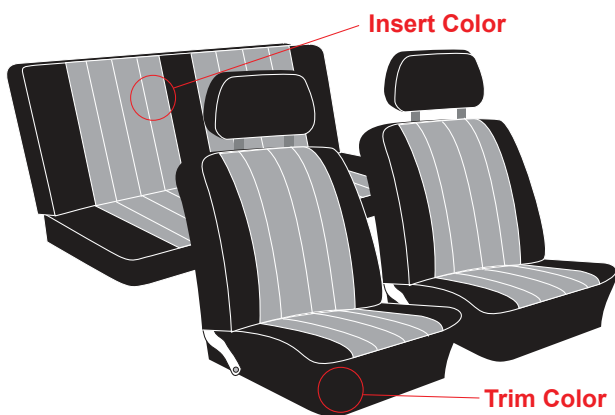

<b>GHIA</b>	<b>Fabrics A</b>	<b>Fabrics B</b>
<b>1956-'57</b> Skinny Backrest	\$700	\$800
<b>1958-'60</b>	\$600	\$700
<b>1961-'65</b>	\$600	\$700
<b>1966-'67</b>	\$600	\$700
<b>1968</b>	\$625	\$725
<b>1969-'74</b>	\$600	\$700
<b>Headrest Covers /1969-'74</b>	\$100/pr	\$125/pr

**Ghia Seat Covers /1961-'68** Include Fabric to cover Seat Back Panels. *Replacement Seat Back Panels, see Page 18.*



## ORIGINAL STYLE HIDDEN STITCH SEAT COVERS

*Hidden Stitch Pleating is the original way early VW seats were sewn. This technique utilizes the "Tuck-and-Roll" method to hide the stitching. Well worth the money for original restorations!*

	<b>Group A</b>	<b>Group B</b>
<b>1954-'55 Bug</b> <i>H Pattern</i>	\$820	\$920
<b>1956-'57 Bug</b> <i>Sewn with 5 pleats, 2¾"</i>	\$1060	\$1260
<b>1958-'59 Bug</b> <i>Sewn with 4 pleats, 3"</i>	\$1060	\$1260
<b>1956-'57 Ghia</b> <i>Sewn with 5 pleats, 2¾"</i> <i>Skinny Backrest (not shown)</i>	\$1250	\$1400
<b>1958-'60 Ghia</b> <i>Sewn with 6 pleats, 2"</i>	\$1250	\$1400
<b>1961-'65 Ghia</b> <i>Sewn with 6 pleats, 2"</i>	\$1060	\$1260

*All Ghia Rear Seat Covers are Sewn with 2 Pleated Insert Sections to Match the Fronts*



1954-'55 Bug



1956-'59 Bug



1958-'60 Ghia



1961-'65 Ghia



1956-'57 Bug



**DELUXE INSERT PIPING** can be added to any Ghia seat cover set

Standard Piping	add \$175
Hand Made Piping	add \$275



**GHIA TIE DOWN SEAT COVER KIT**

- Tufting Twine woven through cover with correct spacing.
- *If replacement seat foam is purchased they will be marked for correct spacing. Tufting Needle also included.*

\$55/kit



1961-'65 Ghia



**REAR SEAT PILLOWS**

- Approximately 7 1/2" Diameter, 15" Long
- Available in any combination of Vinyl, Fabric, and Piping
- Zipper on bottom side allows user to insert a metal rod (if desired) to keep the pillow from rolling.

**FLAT ENDS**

\$185/pr

**HAND TUFTED ENDS with Drawn Buttons**

\$275/pr





## UPHOLSTERING NEEDS



### REPLACEMENT SEAT FRAME TABS

\$3.50/ea      5 for \$15

By replacing broken Seat Frame tabs with new ones, installation can be done the original way. Prevents tight and loose spots on Seat Covers.

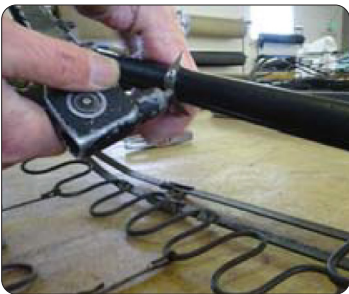

### 1968-'72 BUG BUTTON KIT

\$55/kit

Kit includes 8 buttons, tufting string on each button, needle.



### SEAT BACK PANELS

#### BUG

1953 - '57	\$50/pr
1958 - '72	\$50/pr
1973	\$50/pr
1974 - '76	\$50/pr
1977 - '79	\$50/pr

#### GHIA

* 1956 - '57	\$50/pr
* 1958 - '60	\$50/pr
* 1961 - '67	\$75/pr
* 1968	\$75/pr
1969 - '74	\$55/pr

\* Fabric to cover these panels is included with the seat covers.  
\* Foam to pad panels and piping to upholster is included with the panels.

### GHIA REAR SEAT FRAMES

Seat Bottom Frame	\$160
Seat Backrest Frame	\$160

Available for Coupe or Convertible.  
Metal bar in center of seat cushion frame is not included.







## TYPE 34 GHIA INTERIORS

<b>SEAT COVERS</b>	<b>Group A</b>	<b>Group B</b>
Standard Insert	\$675	\$790
Deluxe Insert	\$725	\$850
Tie-Down Kit <i>See p. 17</i>	\$65	

### REPLACEMENT FOAM CUSHIONS

Front Seat Backrest	\$80/ea
Front Seat Cushion	\$60/ea
Rear Seat Backrest	\$50
Rear Seat Cushion	\$50

### HEADLINER

Perforated Vinyl	\$175
Group A Fabrics/Vinyls	\$250
Group B Fabrics/Vinyls	\$350
Headliner Insulation	\$55

<b>CARPET</b>	<b>Premium Loop or Cutpile</b>	<b>Squareweave Carpet</b>
22pc Full Interior	\$425	\$1800
5pc Trunk	\$240	\$700
7pc Rear Engine	\$310	\$800
Rear Air Vents <i>Bound</i>	Add \$40/pr	
Heater Vents <i>Bound</i>	Add \$40/pr	

### FLOOR INSULATION

4pc Front	\$55
3pc Rear	\$55

<b>DOOR PANELS</b>	<b>Group A</b>	<b>Group B</b>
4 pc/Set <i>Original Style</i>	\$600	\$700
Pockets	\$95/ea	
Piping <i>Original Style</i>	\$100/set	
Door Trim Windlace	\$50	



Custom Red Vinyl, Black Piping  
Custom Upholstered Armrests  
Squareweave Carpet



Black Squareweave Carpet

# THING INTERIORS

	<b>Group A</b>	<b>Group B</b>
<b>COMPLETE REAR SEAT</b> <i>(Must Have Metal Frame)</i> The 2 backrests include new wood panels, plastic wraps, new foam, new covers installed. The Seat Bottom includes new foam and the new cover with zipper.	\$550	\$590
<b>SEAT COVERS, Full Set Front and Rear Cover</b>		
<b>Standard Insert</b>	\$550	\$660
<b>SEAT COVERS, Front Buckets Only</b>		
<b>Standard Insert</b>	\$350	\$425
<b>Deluxe Insert</b>	\$375	\$475
<b>REPLACEMENT FOAM CUSHIONS</b>		
<b>Front Bottom 21-080</b>	\$50/ea	
<b>Front Backrest 21-072C</b>	\$60/ea	
<b>THING CARPET - 9pc Full Interior</b> Includes 14 Hand Sewn Grommets, Heavy Rubberized Backing on 4 Floor Pieces, Shifter & EBrake Bound	\$680	
<b>4pc FLOOR MATS</b> Carpet Mats with Felt Backing Proper Grommet Holes cut and bound	\$325	

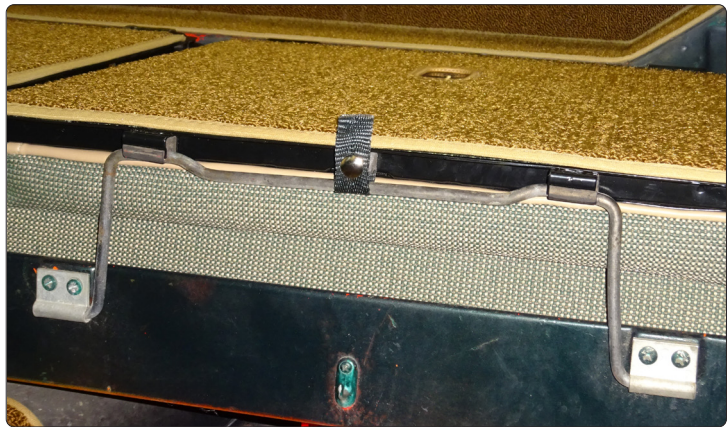

<b>HOLD-DOWN STRAPS</b> <i>For Rear Backrests</i>	\$15/pr
--	---------



## CUSTOM UPHOLSTERED ARMRESTS

<b>STANDARD WRAP</b>	<b>Group A</b>	<b>Group B</b>
1956 - '67 / Bug, Ghia	\$95/pr	\$115/pr
1968 - '72 / Bug, Ghia	\$95/pr	\$115/pr
1973 - '79 / Bug, Ghia	\$165/pr	\$175/pr
<b>CONTRAST THREAD</b>		
1956 - '67 / Bug, Ghia	\$160/pr	\$175/pr
1968 - '72 / Bug, Ghia	n/a	n/a
1973 - '79 / Bug, Ghia	\$185/pr	\$195/pr
<b>STOCK ARMRESTS</b>		
	<i>Black Only</i>	
1956 - '67 / Bug, Ghia	\$60/pr	
1968 - '72 / Bug, Ghia	\$65/pr	
1973 - '79 / Bug, Ghia	\$60/pr	
<b>ARMREST BACKING PLATES</b>	\$12/pr	

Visors  
w/Fingerguards  
Standard Wrap  
1956 - '67 Armrests



1973 - '79  
Armrests



Contrast Thread  
1956 - '67 Armrests



## DOOR PANEL MOUNTING CLIPS & BOOTS

<b>DOOR PANEL CLIPS</b> / Set of 56	\$25
<b>DOOR CLIP BOOTS</b> / Set of 56	\$20



Door Clips MUST be COMPLETELY seated into Clip Hole!!!

## FENDER BEADING

	<b>Group A</b>	<b>Group B</b>
<b>4 - 7' Lengths</b> • Enough for all four fenders • Available in any color vinyl	\$80	\$120

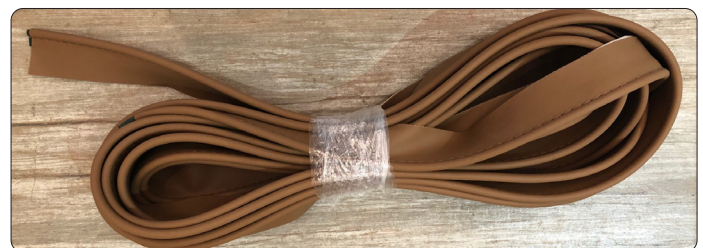

## VAPOR BARRIERS

Vapor Barriers keep the moisture away from your new Door Panels, plus stops wind and dust flow.

<b>VAPOR BARRIERS FOR 4 DOORS</b>	\$15
-----------------------------------	------

Tuck plastic INSIDE lowest metal edge.



## **Ghia Panels** *AVAILABLE FOR ALL YEARS*

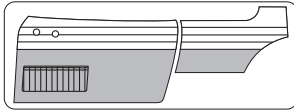

**1956 -'57 STYLE**

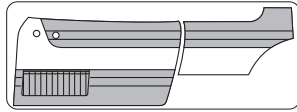

**1958 -'60 STYLE**

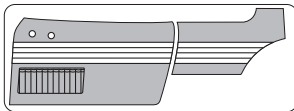

**1961 -'65 STYLE**

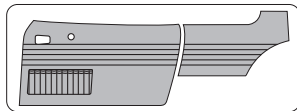

**1966 -'67 STYLE**

- **Any of these Styles can be used on 1956 - '74 Ghia**
- Custom made in the USA
- Prices are for a 4PC set for Coupe, 2PC Fronts for Convertibles.

	<b>Group A</b>	<b>Group B</b>
<b>1956 - '57 STYLE Ghia Coupe</b>	\$460	\$560
<b>1956 - '57 STYLE Ghia Vert</b>	\$400	\$460
Add Original Style Piping		\$100
Add 1 Chrome Line		\$250
Add Pocket		\$75/ea
	<b>Group A</b>	<b>Group B</b>
<b>1958 - '60 STYLE Ghia Coupe</b>	\$650	\$750
<b>1958 - '60 STYLE Ghia Vert</b>	\$525	\$600
Add Original Style Piping		\$100
Add 1 Chrome Line		\$250
Add 2 Piping Lines		\$150
Add Pocket		\$75/ea
	<b>Group A</b>	<b>Group B</b>
<b>1961 - '65 STYLE Ghia Coupe</b>	\$460	\$575
<b>1961 - '65 STYLE Ghia Vert</b>	\$400	\$475
Add Original Style Piping		\$100
Add 2 Piping Lines		\$170
Add Pocket		\$75/ea
	<b>Group A</b>	<b>Group B</b>
<b>1966 - '67 STYLE Ghia Coupe</b>	\$400	\$450
<b>1966 - '67 STYLE Ghia Vert</b>	\$330	\$375
Add Original Style Piping		\$100
Add 2 Piping Lines		\$170
Add Pocket		\$75/ea

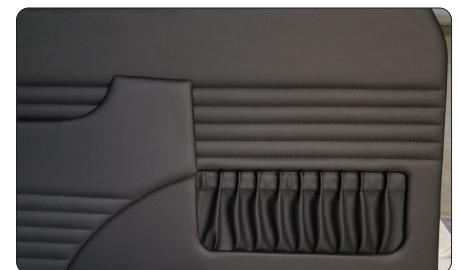

Chrome used for Ghia panels is not original chrome. It is thinner, about 2" shorter, and the rear panel chrome has one cut end that is hidden behind the rear seat.



## DOOR PANELS for BUGS

**Any of these Styles can be used on any year Bug**

- Custom made in the USA
- Prices are for a 4/pc panel set
- Passenger Rear Ashtray cut upon request only

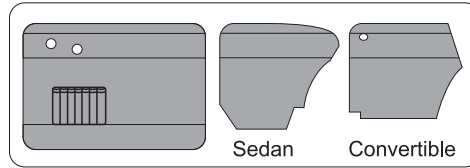

1954 - '55 Style

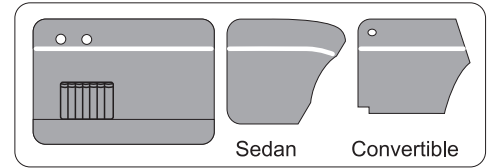

1956 - '57 Style

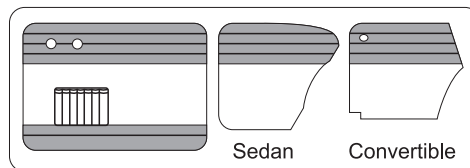

1958 - '59 Style

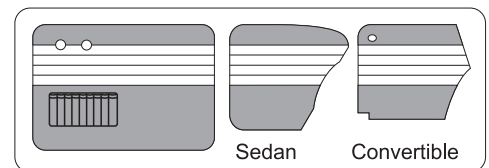

1960 - '64 Style

<b>1954 - '55 STYLE</b>	<b>Group A</b>	<b>Group B</b>
<b>1 Color</b>	\$390	\$475
<b>2 Color (Shown)</b>	\$425	\$525
Add Original Style Piping	\$100	
Add 1 Chrome Line	\$250	
Add Pocket	\$55/ea	



<b>1956 - '57 STYLE</b>	<b>Group A</b>	<b>Group B</b>
<b>1 Color</b>	\$385	\$450
Add Original Style Piping	\$100	
Add 1 Chrome Line	\$250	
Add Pocket	\$55/ea	





**AVAILABLE FOR ALL YEARS**

<b>1958 - '59 STYLE</b>	<b>Group A</b>	<b>Group B</b>
<b>A. Lower Section to Match Top</b>	\$490	\$575
<b>B. Lower Section to Match Insert</b>	\$490	\$575
<b>C. Lower Section a Different Color</b>	\$490	\$575
<b>D. All One Color</b>	\$490	\$575
<i>Add Original Style Piping</i>	\$100	
<i>Add 1 Piping Line</i>	\$75	\$85
<i>Add 2 Chrome Lines</i>	\$400	\$400
<i>Add 1 Chrome Line</i>	\$250	
<i>Add Pocket</i>	\$55/ea	
<i>Knebes Style</i>	add \$155	

1958 -'59  
Style A



1958 -'59  
Style B

1958 -'59  
Style C



<b>1960 - '64 STYLE</b>	<b>Group A</b>	<b>Group B</b>
<b>All 1 Color</b>	\$460	\$575
<b>2 Color</b>	\$490	\$575
<i>Add 2 Piping Lines</i>	\$150	
<i>Add Pocket</i>	\$55/ea	

1960 -'64  
Style





## CUSTOM STYLE PANELS for BUGS ALL YEARS

*Any of these Styles can be used on any year Bug*

- Custom made in the USA
  - Prices are for a 4/pc panel set
  - Passenger Rear Ashtray cut upon request only
- See Page 4 for additional Trim Styles

<b>HIGHWAY 1</b>	<b>Group A</b>	<b>Group B</b>
<b>1 Color / Matching Thread</b>	\$490	\$590
<b>1 Color / Heavy Contrast Thread</b>	\$550	\$670
<b>2 Color / Matching Thread</b>	\$510	\$670
<b>2 Color / Heavy Contrast Thread</b>	\$590	\$670
Add 2 Piping Lines	\$165	\$185
Add Pocket	\$55/ea	

<b>RIDGE ROAD</b>	<b>Group A</b>	<b>Group B</b>
<b>2 Color</b>	\$650	\$750
Add 2 Piping Lines	\$170	\$190
Add Pocket	\$55/ea	

<b>SPLITTY</b>	<b>Group A</b>	<b>Group B</b>
<b>1 Color</b>	\$390	\$490
<b>2 Color</b>	\$410	\$510
Add 1 Piping Line	\$60	\$70
Add Pocket	\$55/ea	

<b>VINTAGE 911</b>	<b>Group A</b>	<b>Group B</b>
<b>All 1 Color</b>	\$875	\$995
<b>2 Color</b>	\$875	\$995
Add 2 Piping Lines	\$150	
Add Pocket	\$55/ea	



**HIGHWAY 1**



**RIDGE ROAD**



**SPLITTY**



**VINTAGE 911**

Order Toll Free 1-800-SEWFINE  
 www.SewfineProducts.com  
 Sales@SewfineProducts.com  
 Phone: 720-287-2127  
 Fax: 720-287-2563



## LITTLE SISTER DOOR PANEL

If any of you have viewed the *Bitchin' Rides* TV Episode called **"The Little Sister"**, you will immediately recognize this vehicle. We designed this Door Panel solely for this Episode, and now it is available for any year Bug. **Sewfine** had the honor of making and installing this interior for the show; an experience we will never forget! It's "Big Brother" was the 21 Window Bus featured on the *Bitchin' Rides* TV episode **"Back to Basics"**, which Sewfine also made and installed the interior for. The 3rd episode, **"Dave's New Toy"** was filmed at our shop.

The **"LITTLE SISTER DOOR PANEL"** is shown with armrests (not included) on both doors, with split Chrome Lines on both sides of the armrest, and chrome on the Rear Panel. This is not a stock arrangement, so required us to use pieces from 2 sets of door chrome. Sunroof Headliner and Seat Covers were made to match the door panels for a stunning single color interior. Shown in Kindig Red Vinyl, Group B Vinyl.



**KINDIG RED ULTRA VINYL**, Group B Pricing



### LITTLE SISTER DOOR PANEL

<b>LITTLE SISTER DOOR PANEL</b>	<b>Group A Vinyl</b>	<b>Group B Vinyl</b>
<i>Chrome included</i>		
<i>Without Pockets</i>	\$875	\$950
<i>1956 - '57 Armrest</i>	\$95	\$115
<i>Pockets</i>	\$55/ea	

### THE BIG BROTHER



## TYPE III CUSTOM DOOR PANELS

**The FLAP PANEL for the Fast/Notch/Square Follows The Long Armrest**

Use for Type III Panels that have the Long Armrest, but still require a 1PC Front Door Panel. We split the Fabric/Vinyl right along the Armrest line, put 1 color on the top, a 2nd Color on the Bottom. The top color continues onto the balance of the panels except for the lower rear panels, which will match the lower color.

	Group A	Group B
<b>9/pc SQUAREBACK</b>	\$820	\$950
<b>6/pc NOTCH/FAST</b>	\$450	\$590



CUSTOM INSERT	Group A	Group B
<b>6/pc NOTCH/FAST</b>	\$570	\$675
<b>9/pc SQUAREBACK</b>	\$850	\$950
<b>6/pc FASTBACK set</b> (as shown above) Tan/Red Plaid, Cali Crimson, 2 Pockets	\$930	

## NOTCHBACK / FASTBACK CUSTOM DOOR PANELS

6/pc Set Includes:

- 2 Front Doors
- 2 Rear Upper Panels
- 2 Rear Lower Panels

	Group A	Group B
<b>1 SIMPLE LINE / 1 Color</b>	\$420	\$550
<b>1 SIMPLE LINE / 2 Color</b>	\$450	\$550
<b>MAIN STREET / 1 Color</b>	\$450	\$550
<b>MAIN STREET / 2 Color</b>	\$490	\$590
<b>MAIN STREET / 1 Color</b> Double Stitch Line, Contrast Thread	\$570	\$675
<b>'58 CLASSIC, STYLE B / 2 Color</b>	\$570	\$675
Add 1 Piping Line to FRONTS ONLY	\$75/ea	
Add Pocket	\$55/ea	



MAIN STREET, Standard single thread line, 1 Color



'58 CLASSIC, Style B



1 SIMPLE LINE, 2 Color, add Piping

## SQUAREBACK CUSTOM DOOR PANELS

## TYPE III ORIGINAL STYLE PANELS / SPLIT FRONTS

9/pc Set Includes: • 2 Front Doors • 2 Rear Upper Panels • 2 Rear Lower Panels • 2 Rear Cargo Side Panels • 1 Hatch Panel	Group A	Group B
<b>1 SIMPLE LINE</b> / 1 Color	\$775	\$875
<b>1 SIMPLE LINE</b> / 2 Color	\$840	\$940
<b>MAIN STREET</b> / 1 Color	\$760	\$860
<b>MAIN STREET</b> / 2 Color	\$850	\$950
<b>MAIN STREET</b> / 1 Color Double Stitch Line, Contrast Thread	\$850	\$850
<b>'58 CLASSIC, STYLE B</b> / 2 Color	\$770	\$850
Add 1 Piping Line to FRONTS ONLY	\$75/pr	
Add Pocket	\$55/ea	

2/pc Front Split Panel sets are only for vehicles with Top Pads and Long Armrests on Front Doors.

	Group A	Group B
<b>1961 - '65 NOTCHBACK</b> 8/pc Set Includes: • 4/pc Split Front Panels (2 panels per door) • 2pc Upper Rear Panels • 2pc Lower Panels	\$625	\$760
<b>1961 - '65 SQUAREBACK</b> 11/pc Set Includes: • 4/pc Split Front Panels • 2 Rear Upper Panels • 2 Rear Lower Panels • 2 Rear Cargo Side Panels • Hatch Panel	\$920	\$1050
Add Pocket	\$55/ea	



MAIN STREET, Double Stitch Line, Contrast Thread, 1 Color





## BUG HEADLINERS

**CONVERSION STYLE HEADLINERS** are a modified headliner, also called a “1 Piece” headliner. The entire roof is 1 piece, plus 5 additional trim pieces. A Conversion Headliner is sewn with “Hidden Windlace”, so it is not seen after installation. Sometimes called “Easy Install”.

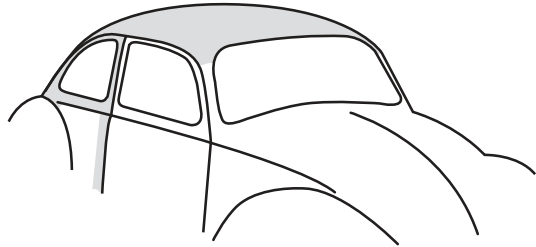

		PERFORATED VINYL	GROUP A	GROUP B
<b>BUG SEDAN</b>	1947-'57	\$180	\$240	\$300
	1958-'63	\$180	\$240	\$300
	1964-'67	\$180	\$240	\$300
	1968-'77	\$180	\$240	\$300
<b>BUG RAG/SUNROOF</b>	1964-'67	\$200	\$275	\$350
	1968-'79	\$200	\$275	\$350

**ORIGINAL STYLE HEADLINERS** are multipiece, like original. The Windlace is sewn “Exposed” for Vinyl headliners, so it is visible after installation. Original Headliners made of Group A or B fabric have the Windlace Hidden.

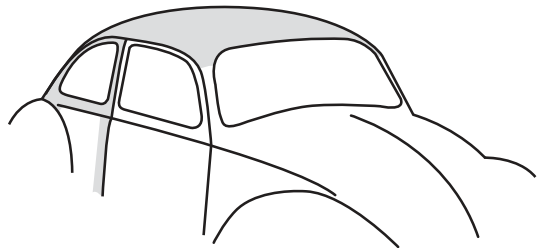

		PERFORATED VINYL	GROUP A	GROUP B
<b>BUG SEDAN</b>	1947-'57	\$250	\$270	\$370
	1958-'63	\$250	\$270	\$370
	1964-'67	\$250	\$270	\$370
	1968-'79	\$250	\$270	\$370
<b>BUG RAG/SUNROOF</b>	1947-'56	\$270	\$295	\$390
	1956-'57	\$270	\$295	\$390
	1958-'62	\$270	\$295	\$390
	1963 Only	\$270	\$295	\$390
	1964-'67	\$250	\$285	\$375
	1968-'79	\$250	\$285	\$375

### HEADLINER INSULATION

Insulation kits are Jute Padding, each precut per vehicle.

**36" INSULATION** (per/yd) | \$20/yd

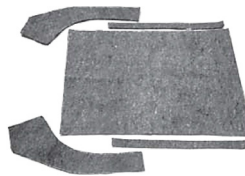

<b>BUG</b>	All Sedan Conversion	\$50
	1964 and Up Sunroof Conversion	\$50
	All Sedan Original	\$50
	to 1963 Ragtop Original	\$40

### HEADLINER BOWS

• Headliner rods cut to 48" lengths (Some trimming required)

1958-'63	<b>BUG</b> 4/pc	\$45
1958-'63	<b>SUNROOF</b> 1/pc	\$15
1964-'67	<b>BUG</b> 5/pc	\$55
1968-Up	<b>BUG</b> 6/pc	\$65
<b>BOW CAPS</b> 14/ea Anti-Rattle		\$15

**HEADLINER TUCKING TOOL** \$35



### OVAL WINDOW HEADLINER BOWS

• Size specific for Ovals only

To-'57	<b>BUG SEDAN</b> 4/pc	\$60
To-'57	<b>ALL RAGTOP</b> 1/pc	\$15

## GIHA HEADLINERS

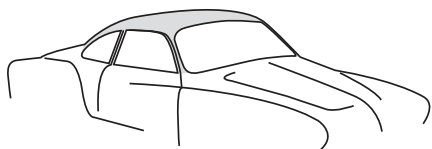

<b>GIHA</b>	PERFORATED VINYL	GROUP A	GROUP B	HEADLINER INSULATION Coupe (1/pc)
1956-'57	\$160	\$195	\$275	\$40
1958-'62	\$160	\$195	\$275	\$40
1963-'74	\$160	\$195	\$275	\$40

## TYPE III HEADLINERS

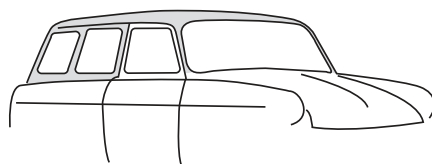

<b>TYPE III</b>	PERFORATED VINYL	GROUP A	GROUP B	HEADLINER INSULATION (1/pc)
<b>SQUAREBACK</b>	\$240	\$300	\$390	\$60
<b>FASTBACK</b>	\$185	\$270	\$360	\$50
<b>NOTCHBACK</b>	\$180	\$250	\$340	\$40
Type III Sunroofs	Add \$90			

### POP-OUT QUARTER WINDOW TRIM

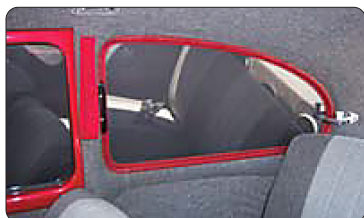

Black or White	\$30
Red or Bright White	\$80
12 feet. Enough for both windows.	\$2.50/ft

### SPRAY ADHESIVE

Formulated for the automotive professional. Easily bonds heavier weight materials to metal, wood, and plastic. Also use for Headliners and carpet installations. Excellent heat and water resistance.



**\$20/can**  
 2-3 cans for Headliner Install  
 2-3 cans for Carpet/Insulation Install

### CRANKBACK SUNROOF HEADLINER BOWS

- 3/pc sets include 1 Straight Bow & 2 Curved Bows.
- Cut to length and properly curved.
- Includes 4 end springs to hang curved bows.

1964-'67 <b>SUNROOF</b> 3/pc	\$75
1968-Up <b>SUNROOF</b> 3/pc	\$75



### BUG REAR WINDOW PADDING

\$10

Rear window padding is thin foam used in Original Style headliners





## HEADLINER ACCESSORIES

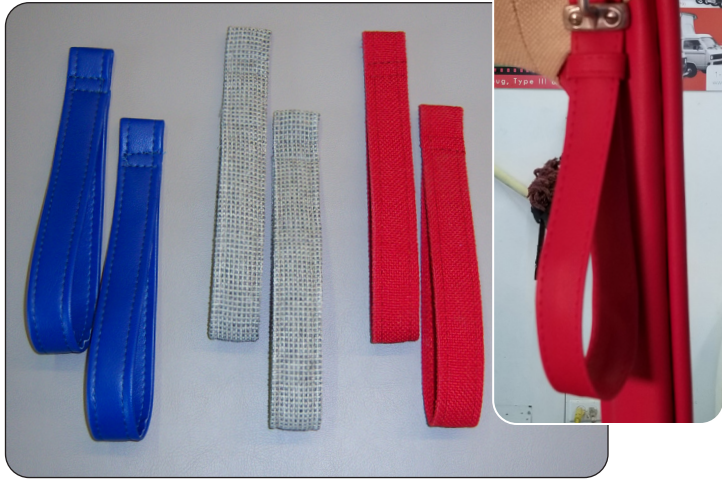

### SUNROOF COVERS

Designed to replace your existing Factory Bug Sunroof Cover (through 1963). See page 50 for color selections.

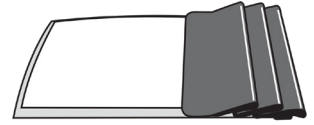

BUG REPLACEMENT SUNROOF COVER	Haartz Vinyl	Haartz Canvas
1954 - '56 (all corners square)	\$200	\$275
1956 Only (2 round, 2 square)	\$200	\$275
1957 - '63 (all round corners)	\$175	\$250
<b>Replacement Roller Kit</b>	\$55	
<b>Hot Rod Canvas</b>	add \$200	

### CUSTOM ASSIST STRAPS

	Group A	Group B
1954 - '57 BUG SEDAN	\$65/pr	\$75/pr
1958 - '67 BUG SEDAN	\$50/pr	\$60/pr
1968 - '77 BUG SEDAN	\$50/pr	\$60/pr
1958 - '76 BUG VERT	\$65/pr	\$75/pr
<b>Contrast Thread</b>	add \$10/pr	

### REAR RAGTOP METAL BAR

All Bug Ragtop models require this metal strap at the rear end of the Sunroof opening. Without the Bar, the headliner will "Batwing" leaving you with a wavy line.

**Sunroof Metal Bar** (Includes mounting clips.) \$25

### COAT HOOKS

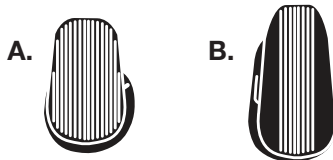

#### COAT HANGER (Bug Sedan)

A. 1958 - '67 / White	\$20/pr
A. 1958 - '67 / Black	\$20/pr

#### COAT HANGER (Bug Sedan)

B. 1968 - '77 / White	\$20/pr
B. 1968 - '77 / Black	\$20/pr

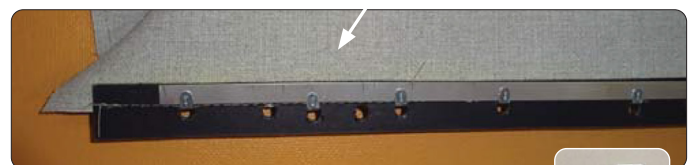
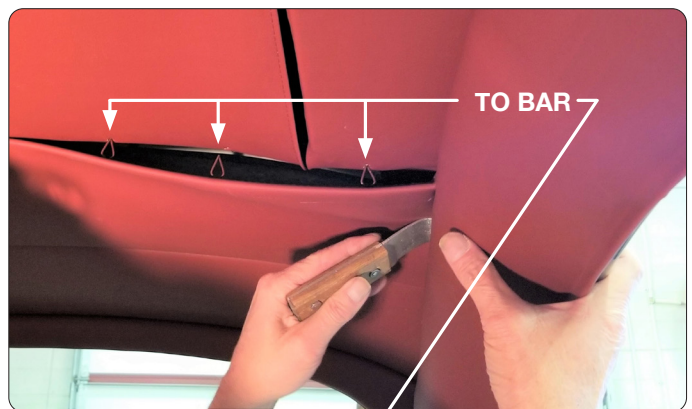

### TUCKING TOOL

Use for tucking plastic for Headliner Installation \$30





## CUSTOM SUN VISORS

Available in any Vinyl or Fabric

	<b>Group A</b>	<b>Group B</b>
<b>BUG</b>		
<b>1958 - '64 Sedan</b>	\$150	\$175
<b>1965 - '67 Sedan</b>	\$190	\$190
<b>1968 - '77 Sedan</b>	\$170	\$170
<b>1965 - '72 Convertible</b>	\$170	\$170
<b>1973 - '79 Convertible</b>	\$170	\$170
<b>GHIA</b>		
<b>1956 - '64</b>	\$150	\$150
<b>1965 - '74</b>	\$170	\$170
<b>TYPE III</b>		
<b>1961 - '74</b>	\$185	\$185



### VISOR MOUNTS (Bug, Ghia)



<b>1965 - '67 / White</b>	\$10/pr
<b>1965 - '67 / Black</b>	\$10/pr

### VISOR MOUNTS (Bug, Ghia, Type III)



<b>1968 - '79 Bug, 1968 - '74 Ghia, - '73 Type III White</b>	\$10/pr
<b>1968 - '79 Bug, 1968 - '74 Ghia, - '73 Type III Black</b>	\$10/pr



<b>PIPING ACCENT</b>	Add \$45/pr
<b>FINGER GUARD</b>	Add \$30/pr
<b>CONTRAST THREAD</b>	Add \$40/pr
<b>PLAID</b>	Add \$75/pr



## CONVERTIBLE HEADLINERS

<b>BUG</b>	<b>Vinyl Perforated Crush Grain</b>	<b>Fabric &amp; Vinyls Group A</b>	<b>Fabric &amp; Vinyls Group B</b>
1954 -'57 (Chassis #39038)	\$380	\$680	\$850
1957 (Chassis #39039) -'58	\$380	\$680	\$850
1959 -'63	\$380	\$680	\$850
1964	\$380	\$680	\$850
1965 -'71	\$380	\$680	\$850
1972	\$380	\$680	\$850
1973 -'79	\$380	\$680	\$850
<b>GHIA</b>			
1958 - '64	\$450	\$680	\$850
1965 -'69½ (Plastic Window)	\$450	\$680	\$850
1969½ -'74 (Glass Window)	\$450	\$680	\$850

A portion of the Ghia Headliner is sewn into the Convertible Top. They should be ordered at the same time.



## TOP BOOTS

<b>BUG</b>	<b>Group A Vinyl</b>	<b>Group B Vinyl</b>	<b>Haartz Canvas</b>	<b>Hot Rod Canvas</b>
1950 - '64	\$270	\$320	\$575	\$700
1965 - '71	\$270	\$320	\$575	\$700
1972 Only	\$270	\$320	\$575	\$700
1973 - '75½	\$270	\$320	\$575	\$700
1975½ -'77	\$270	\$320	\$575	\$700
1977 -'79	\$270	\$320	\$575	\$700
<b>GHIA</b>				
1958 - '69½	\$270	\$320	\$575	\$700
1969½ - '74	\$270	\$320	\$575	\$700

**CONTRASTING PIPING** Add \$90

## CONVERTIBLE TOP PAD KITS

Includes blanket, foam pad, rear window pads, and bow straps.

### **BUG** Top Pad Set

<b>To 1964</b>	\$240
<b>1965-'71</b>	\$240
<b>1972</b>	\$260
<b>1973-'79</b>	\$275

### **GHIA** Top Pad Set

<b>1957 -'69½</b> (cars w/ plastic windows)	\$215
<b>1969½ -'74</b> (cars w/ glass windows)	\$215

## CONVERTIBLE TOPS

<b>BUG</b>	<b>Haartz Canvas</b>	<b>Hot Rod Canvas</b>
1954 - '57	\$890	\$1150
1958 - '62	\$850	\$1100
1963 - '67½	\$850	\$1100
1967½ - '72	\$850	\$1100
1973 - '79	\$850	\$1100

### **GHIA** (Includes Rear Window Headliner Facing sewn into top)

1958 - '59	\$1100	\$1250
1960 - '67½ (w/ Wood Base Bow)	\$1000	\$1250
1967½ - '69½ (w/ Plastic Rear Window & Rear Cable)	\$1000	\$1250
1969½ - '74 (w/ Rubber Seal for Rear Glass Window)	\$1000	\$1250

**Plastic Rear Window 1969½ - '74** Add \$95  
 Substitute a plastic rear window sewn into 1969-'74½ Ghia (Prevents Leaking)

### **GHIA ITEMS NOT SHOWN**

<b>Header Bow Plates</b>	Call
<b>Header Bow Screws</b>	Call
<b>Header Bow Pins</b>	\$40/pr
<b>Top Pin Seals</b>	\$17/pr



Upholster your hinge covers to match your seat covers and door panels  
 Add \$150/pr

## GHIA CONVERTIBLE PARTS

<b>C. TACK BOW</b> (Wood above rear window)	
1957 - '69½	\$290
1969½ - '74	\$290

<b>D. REAR WINDOW TENSION CABLE</b> (for use w/Glass Window)	
1969½ - '74	\$28

<b>E. BASE BOW</b> (Wood)	
1957 - '67	\$345

<b>F. REAR TENSION CABLE</b>	
1967½ - '74	\$30

<b>G. SIDE SEAL SET</b> (4/pc)	
1957 - '74	\$90

<b>H. PILLAR SEAL SET</b> (2/pc)	
1957 - '74	\$50

<b>I. SIDE TENSION CABLE</b> (pr)	
1957 - '74	\$16

<b>J. BUSHINGS</b> (pr)	
1957 - '74	\$48

<b>K. INSIDE HEADER BOW COVER</b> (ABS Plastic)	
1969½ - '74/Black	\$50
1969½ - '74/White	\$50

<b>L. HEADER BOW SEAL</b>	
1957 - '69½	\$22
1969½ - '74	\$22

<b>M. HEADER BOW</b> (Wood)	
1959 - '69½	Call
1969½ - '74 w/ Glass Window	\$405

<b>N. INSIDE HINGE COVER</b> (ABS Plastic)	
1958 - '66½/Black	\$250/pr
1966½ - '69½/Black	\$250/pr
1969½ - '74/Black	\$250/pr
1969½ - '74/White	\$250/pr



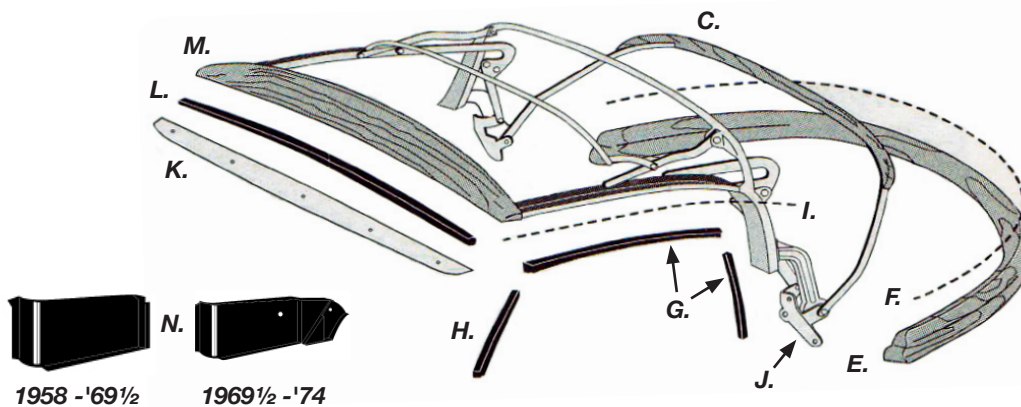

## BUG CONVERTIBLE PARTS

### D. REAR WINDOW SEAL (Cal Look)

1953 - '57	\$20
1958 - '63	\$25
1964 - '75½	\$30
1975½ - '79	\$40

### E. REAR WINDOW WOOD INSERT

1964 - '75½	\$150
1975½ - '79	\$150

### E2. REAR WINDOW FRAME & WOOD INSERT

1964 - '75½	\$350
1975½ - '79	\$350

### F. TACK BOW WOOD (Above Rear Window)

1952 - '60	\$225
1961 - '64	\$225
1965 - '71	\$225
1972 - '79	\$225

### G. BASE BOW (Wood)

1950 - '67½	\$290
1967½ - '71	\$275

### H. REAR TENSION CABLE

1967½ - '79	\$35
-------------	------

### I. SIDE SEALS (Set of 6)

1954 - '79	\$50
------------	------

### J. OUTSIDE QUARTER FACINGS (Wood)

1961 - '64	\$200/pr
1965 - '71	\$200/pr

### K. INSIDE FACINGS (Wood)

1952 - '60	\$125/pr
1961 - '71	\$125/pr

### L. HEADER BOW PLATES

1957 - '67	\$150 and up
1968 - '72	\$150 and up

### M. HEADER BOW (Wood)

1950 - '56	\$300
1957 - '64	\$300
1965 - '67	\$300
1968 - '72	\$300

### N. HEADER BOW SEAL

1950 - '67	\$15
1968 - '72	\$20
1973 - '79	\$30

### O. INSIDE HEADER BOW COVER

1956 - '64	\$55
1965 - '67	\$55
1968 - '71	\$55
1972	\$55

### P. SIDE TENSION CABLES

All Years	\$20/pr
-----------	---------

### Q. PILLAR SEALS

All Years	\$20/pr
-----------	---------

### ALIGNMENT PINS

1968 - '72	\$50/pr
------------	---------

### ALIGNMENT PIN SEALS

1968 - '72	\$15/pr
------------	---------

### HINGE COVERS/ABS PLASTIC

1965 - '67 / Black	\$85/pr
1968 - '79 / Black	\$85/pr
1968 - '79 / White	\$85/pr



Upholster your hinge covers to match your seat covers and door panels  
Add \$75/pr

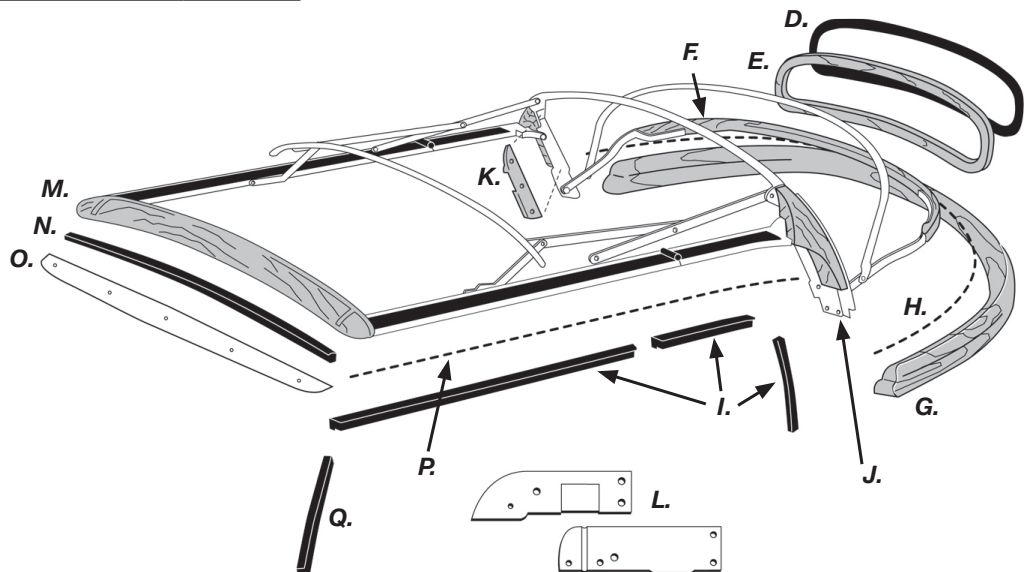

## TYPE III CARPET KITS

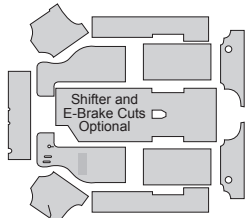

12/pc Front Kit

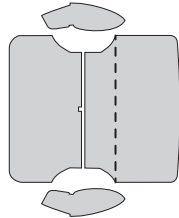

4/pc Rear Cargo Squareback

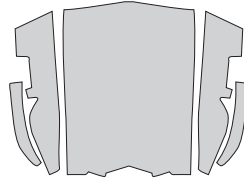

3pc Rear Engine Fastback/Notchback

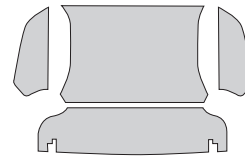

Front Trunk 1961-'70

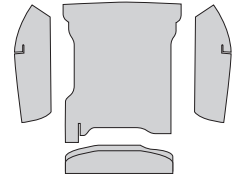

Front Trunk 1971-'74

### 12pc FRONT CARPET KIT

Cut Year Specific for any FASTBACK, NOTCHBACK, or SQUAREBACK. Please specify Automatic or Manual

Loop or Cutpile	\$425
-----------------	-------

Heater Vent Cuts	\$75/4pc
------------------	----------

### 4pc REAR CARGO AREA

Cut Year Specific for SQUAREBACK

Loop or Cutpile	\$240
-----------------	-------

### 3pc REAR ENGINE AREA

All NOTCHBACK

Loop or Cutpile	\$220
-----------------	-------

### 5pc REAR ENGINE AREA

1965-'74 FASTBACK

5/pc	\$250
------	-------

### FRONT TRUNK KITS

1961 - '70  
 Cut Year Specific for any FASTBACK, NOTCHBACK, or SQUAREBACK.

Loop or Cutpile	\$200
-----------------	-------

### FRONT TRUNK KITS

1971 - '74  
 Cut Year Specific for any FASTBACK, NOTCHBACK, or SQUAREBACK.

Loop or Cutpile	\$200
-----------------	-------

## SQUAREWEAVE



### SQUAREWEAVE CARPET KITS FOR TYPE III

12pc FLOOR	All Years	\$1600
3pc or 5pc REAR ENGINE	Fastback/Notchback	\$675
4pc CARGO	Squareback	\$620

## CARPET INSULATION

Thick jute padding. Reduces road heat in the summer, and insulates in the winter. Also acts as soundproofing. If Hush Mat is used, this installs over the Hush Mat.

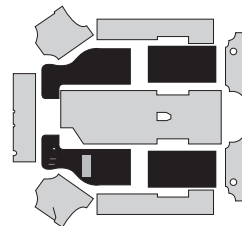

4pc Floor

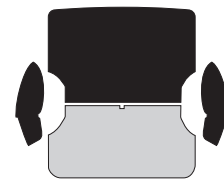

3pc Rear

### TYPE III FLOOR INSULATION

4pc FLOOR	All Type III	\$55
3pc REAR	Fast/Notch	\$65
3pc REAR	Squareback	\$75



# GHIA CARPET KITS

## 20 PC FULL INTERIOR CARPET KITS

GHIA COUPE	Loop or Cutpile
1956 - '59 / 1960 - '64 1965 - '67 / 1968 Only 1969 - '72 / 1973 - '74	\$375

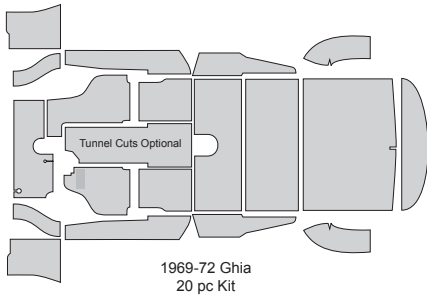

## 20 PC FULL INTERIOR CARPET KITS

GHIA CONVERTIBLE	Loop or Cutpile
1969 - '72 / 1973 - '74	\$375

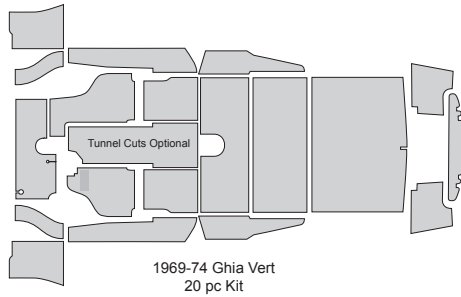

## 19 PC FULL INTERIOR CARPET KITS

GHIA CONVERTIBLE	Loop or Cutpile
1956 - '59 / 1960 - '64 1965 - '67 / 1968 Only	\$375

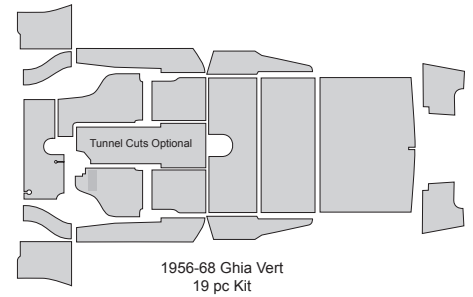

4/pc Floor Mat Set	\$105
2/pc Front Floor Mats	\$80
Heater Vent Cuts Bound (to '68)	\$35/pr
RHD Kits	Add \$75
Special Binding Colors, Cloth	Add \$30
Special Binding Colors, Canvas	Add \$125

Rear Shelf Vinyl Covered Masonite	\$40
--------------------------------------	------

## GHIA TRUNK CARPET KITS

3/pc w/Masonite 1958 - '60	\$170
3/pc w/Masonite 1961 - '67	\$170
3/pc w/Masonite 1968 - '74	\$170
15" Spare Tire Cover	\$75

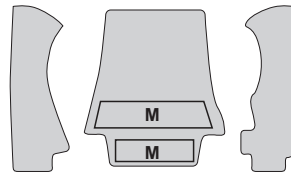

M Masonite board backing included

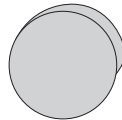

Spare Tire Cover



Ghia Coupe Carpet, Tan Squareweave

GHIA FLOOR INSULATION	4/pc Floor	3/pc Rear
1956 - '68	\$55	\$55
1969 - '74	\$55	\$55

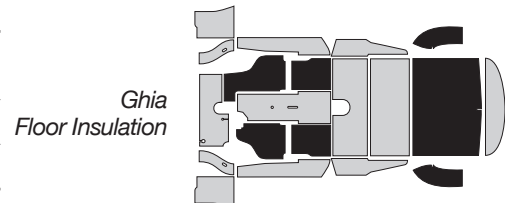

**FRONT KICK PANEL / CARPET INSTALLATION SEQUENCE:**

1. Glue Door Trim Windlace into position along front edge of door opening
2. Place Floating Kick into position so the pre-punched holes lay on top of Windlace
3. Place Metal Channel on top of Windlace/Floating Kicks while aligning holes.
4. Screw through Metal Channel, Floating Kick, and Windlace.
5. Install Front Kick Carpet piece, inserting unbound edge inside of metal lip.

**GHIA FLOATING KICK PANELS**

Floats over the Front Firewall Heater Tubes to prevent carpet from sinking into the firewall.

\$60/pr.



Ghia Floating Kicks

**DOOR TRIM WINDLACE**

Available in Any Color Vinyl. Enough for 4 Door Openings.

\$60



Door Trim Windlace

**REPLACEMENT STAINLESS DOOR CHANNELS**

For Front Door openings  
 • 2 Stainless Steel Channels Predrilled  
 • 8 screws

\$60/pr.



Stainless Channels

**CARPET SELECTIONS**

All Carpet Kits Cloth Bound

**PREMIUM LOOP CARPET**

80" Wide

\$55/yd



Medium Saddle

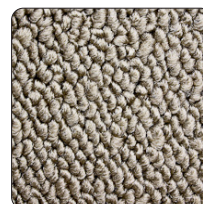

Oatmeal

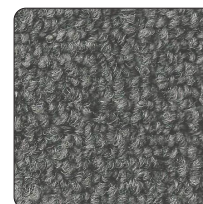

Salt&Pepper Grey #407

**PREMIUM LOOP CARPET**

40" Wide

\$35/yd



Black #601



Brown #610

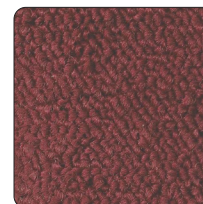

Cranberry Red #615

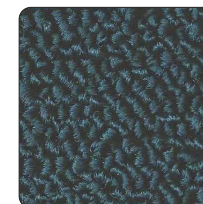

Navy #602

**PREMIUM CUTPILE CARPET**

72" Wide

\$55/yd



Smoke



Carmel

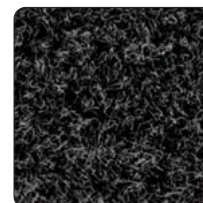

Charcoal



Cocoa



# BUG FRONT CARPET KITS

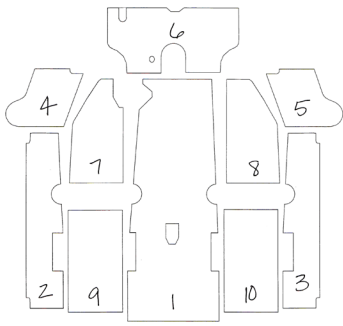

1956 - '72 Standard

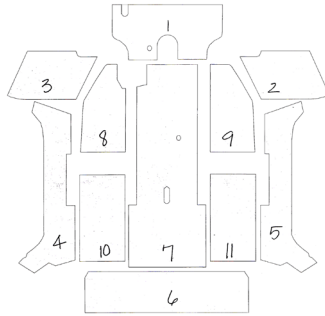

1956 - '64 Convertible

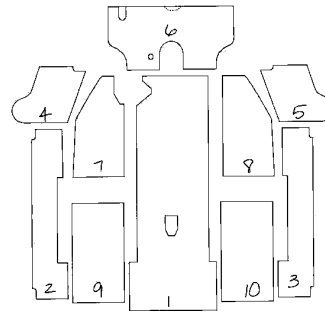

1973 - '75 Super Beetle

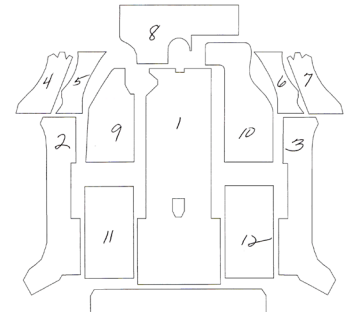

1971 - '72 Convertible

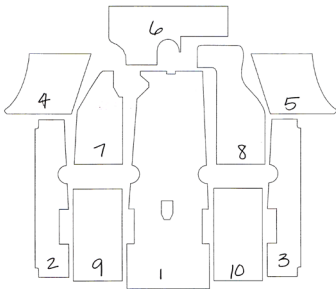

1973 - '77 Standard

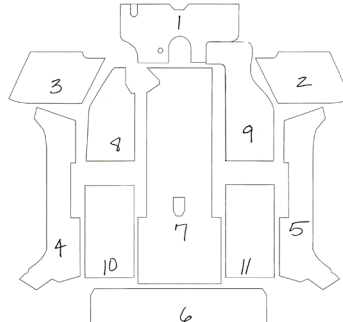

1965 - '70 Convertible

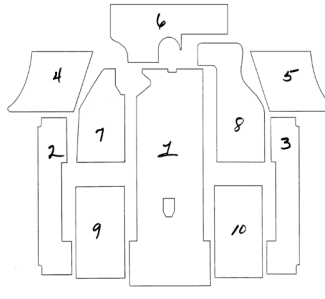

1971 - '72 Super Beetle

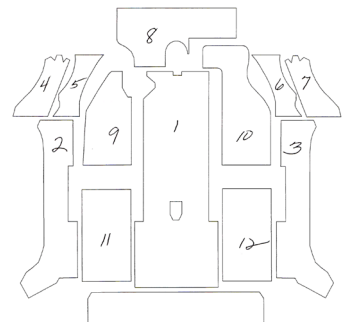

1973 - '79 Convertible

## STANDARD SEDAN 10/pc

	Loop or Cutpile
1949 - '55 With Roller Pedal	\$265
1949 - '55 Without Roller Pedal	\$265
1956 - '64 With Roller Pedal	\$265
1956 - '64 Without Roller Pedal	\$265
1957 (Specify Heater Vent Location)	\$265
1958 - '64	\$265
1965 - '67	\$265
1968 Only	\$265
1969 - '72	\$265
1973 - '77	\$265

## STANDARD CONVERTIBLE 11/pc

	Loop or Cutpile
1950 - '55 With Roller Pedal	\$275
1950 - '55 Without Roller Pedal	\$275
1956 - '57 With Roller Pedal	\$275
1956 - '57 Without Roller Pedal	\$275
1957 (Specify Heater Vent Location)	\$275
1958 - '64	\$275
1965 - '67	\$275
1968 Only (with footrest)	\$275
1969 - '70 (with footrest)	\$275
1973 - '77	\$275

## SUPER SEDAN 10/pc

	Loop or Cutpile
1971 - '72	\$265
1973 - '75	\$265

## SUPER CONVERTIBLE 13/pc

Color Selections on p. 39	Loop or Cutpile
1971 - '72	\$290
1973 - '79	\$290

### Heater Vent Cuts Bound (to '68)

\$30/pr

### RHD Kits

Add \$75

### Special Binding Colors, Cloth

Add \$30

### Special Binding Colors, Canvas

Add \$125

Color Selections: Page 39



## BUG REAR CARPET KITS Masonite Boards Sold Separately

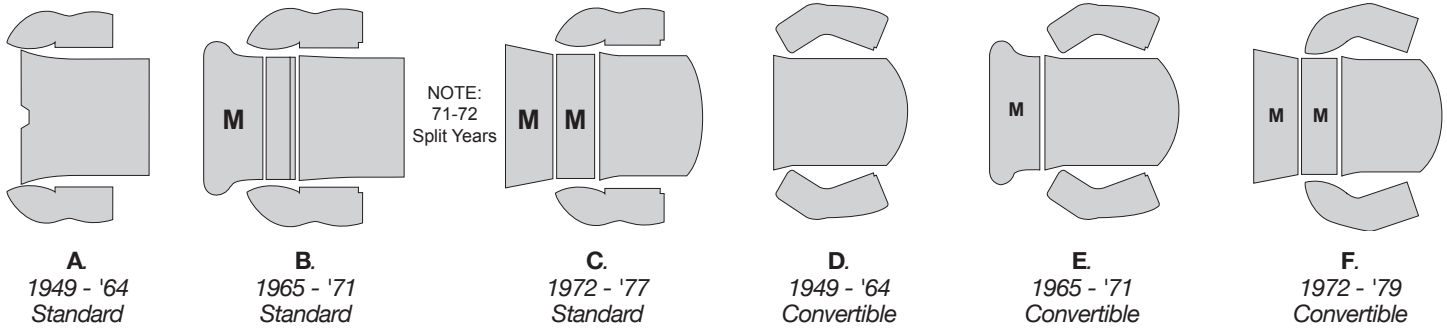

### BUG SEDAN REAR

	Loop or Cutpile
A. 1949 - '55 3/pc	\$100
A. 1956 - '64 3/pc	\$100
B. 1965 - '71 5/pc	\$150
C. 1972 - '77 5/pc	\$150

### SUPER SEDAN REAR

	Loop or Cutpile
B. 1971 Only 5/pc	\$150
C. 1972 - '75 5/pc	\$150

### CONVERTIBLE REAR

	Loop or Cutpile
D. 1949 - '64 3/pc	\$110
E. 1965 - '71 4/pc	\$120
F. 1972 - '79 5/pc	\$150

**M. MASONITE BACKING BOARDS**

\$30/ea

## TRUNK CARPET KITS Masonite Boards Included

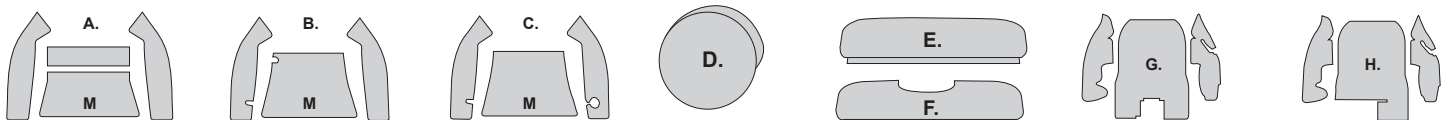

### SEDAN TRUNK KITS

	Loop or Cutpile
A. 1950 - '61 4/pc w/Masonite	\$175
B. 1961 - '67 3/pc w/Masonite	\$175
C. 1968 - '77 3/pc w/Masonite	\$175
D. 15" Spare Tire Cover	\$75

### WIRE COVERS (Can be covered with Carpet, Fabric, or Vinyl)

	Uncovered	Covered
E. 1950 - '67	\$40	\$80
F. 1968 - '77 Standard	\$40	\$80
F. 1971 - '72 Super	\$40	\$80

1971 - '77 fits only without fan on Airbox

### SUPER BEETLE TRUNKS

G. 1971 - '72 4/pc without Masonite	\$140
H. 1973 - '79 4/pc without Masonite	\$140



## CUSTOM EBRAKE AND SHIFTER BOOTS

Custom Ebrake Boots are intended to install *OVER* the Stock Boot.

### CUSTOM SHIFTER & EBRAKE BOOTS

<b>Custom Shifter or Ebrake Boot, Original</b>	\$40/ea
<b>Custom Shifter Boot / Empi</b>	\$45/ea
<b>Custom Shifter Boot / Scat</b>	\$45/ea
<b>French Seaming/Contrast Thread</b>	Add \$10
<b>Stock Ebrake Boot</b>	\$15



### HUSH MAT

Hush Mat is easy to use. Peel and stick sheets are cut with household scissors. Use to reduce the metal "tin can" sound, or engine noise anywhere in your car. Also use to reduce heat from big motors. About 8-10 pieces strategically placed make a significant difference. Some choose full coverage.

<b>1 Sheet / 12" X 23"</b>	\$18
<b>Box of 20</b>	\$350



(Squareweave Carpet Kits have a grommet-bound shifter and EBrake.)

### SPRAY ADHESIVE

For use with Carpet, Headliner, and Insulation Installs. We recommend 2-3 cans for Carpet and Insulation.



**\$20/can**  
2-3 cans for Headliner Install  
2-3 cans for Carpet/Insulation Install

### TUNNEL CUTS

We will cut and bind the tunnel for the stock shifter and eBrake on all Loop and Cutpile Carpet Kits unless otherwise requested. The carpet is cut and rolled to the back side, creating an attractive "Rolled Carpet" edge on the front side.



## CARPET INSULATION

Thick jute padding which reduces road heat in the summer, and insulates in the winter. Also acts as soundproofing. If Hush Mat is used, this installs over the Hush Mat.

<b>BUG FLOOR INSULATION</b>	4/pc Floor	3/pc Rear
1949 - '55	\$45	\$45
1956 - '72	\$45	\$45
1973 - '79	\$45	\$45
<b>Bulk 36" Wide</b>	\$30/yd	
<b>Bulk 72" Wide</b>	\$50/yd	

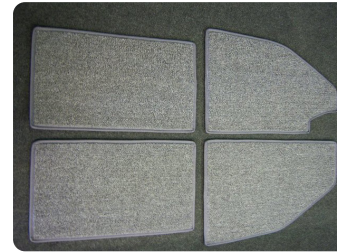
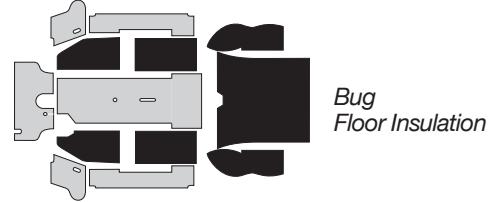

## FLOOR MATS

	4/pc	2/pc
<b>Floor Mats</b>	\$100/set	\$65/pr.

## REAR SEAT RISERS

These Kick Panels under your Rear Seat can be covered in Carpet, Tweed, or Vinyl. Made with 1/8" Masonite backing boards.

<b>A. 1956 - '77 / Sedan</b>	\$50/pr
<b>B. 1956 - '59 / Convertible</b>	\$75/pr
<b>C. 1960 - '79 / Convertible</b>	\$45/pr
<b>Heater Grommets (Installed)</b>	Add \$50/pr

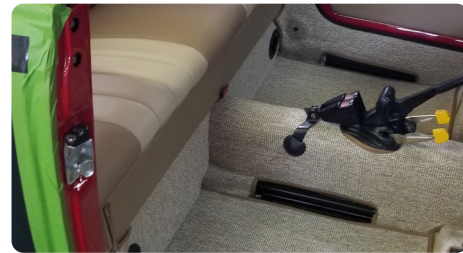
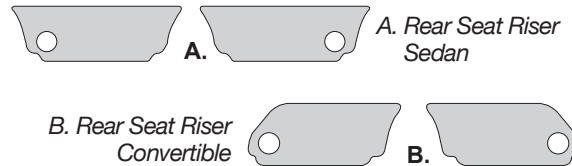

### CHROME TRIM RINGS (Includes Installation)

- For Heater Outlet / 1956 - '60
  - Only for rectangular cutouts near the door opening
- \$85pr



### 1973 - '79 PEDESTAL WRAPS

Covers front hump for 3-Point Seat Mounts / Bug \$45/fr.



# 100% WOOL GERMAN SQUAREWEAVE CARPET

## TRIM KITS

## PARTIAL FLOOR KITS

## FULL FLOOR KITS

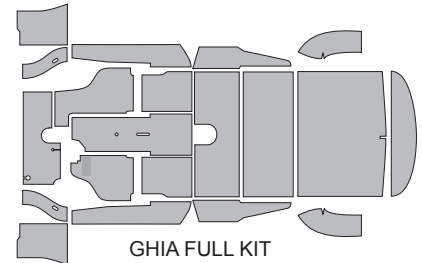
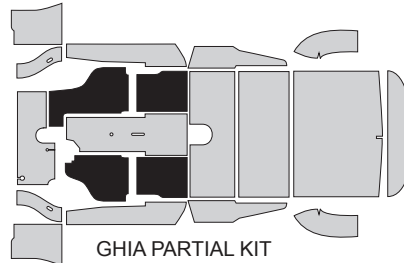
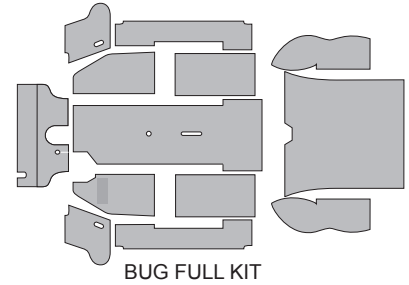
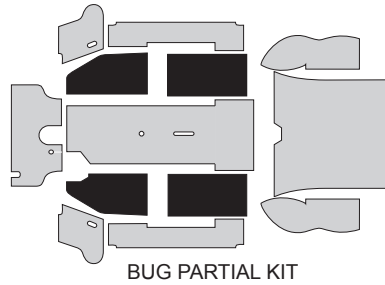
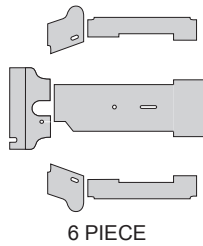
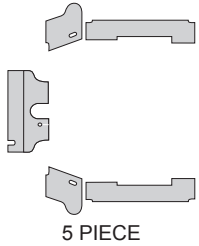

Matching Canvas Binding on all kits. Shifter, EBrake, and Heater Vent Cuts are Grommet Bound.

		TRIM KITS	PARTIAL FLOOR KITS	FULL FLOOR KITS
<b>BUG SEDAN</b>	1949 - '59 With Roller Pedal	6/pc \$780	9/pc \$975	13/pc \$1450
	1949 - '59 Without Roller Pedal	6/pc \$780	9/pc \$975	13/pc \$1450
	1957 (Specify Heater Vent Location)	6/pc \$780	9/pc \$975	13/pc \$1450
	1960 - '64 With Roller Pedal	5/pc \$700	8/pc \$900	13/pc \$1450
	1960 - '64 Without Roller Pedal	5/pc \$700	8/pc \$900	13/pc \$1450
	1965-'77	5/pc \$700	10/pc \$1000	15/pc \$1500
<b>BUG CONVERTIBLE</b>	1949 - '59 With Roller Pedal	7/pc \$800	10/pc \$950	14/pc \$1570
	1949 - '59 Without Roller Pedal	7/pc \$800	10/pc \$950	14/pc \$1570
	1957 (Specify Heater Vent Location)	7/pc \$800	10/pc \$950	4/pc \$1570
	1960 - '64 With Roller Pedal	6/pc \$800	9/pc \$950	14/pc \$1570
	1960 - '64 Without Roller Pedal	6/pc \$800	9/pc \$950	14/pc \$1570
	1965-'70	6/pc \$800	10/pc \$950	15/pc \$1600
	1970-'71½	8/pc \$900	14/pc \$1450	18/pc \$1800
1971½-'79	8/pc \$900	14/pc \$1450	18/pc \$1800	
<b>GHIA COUPE</b>	1956 - '74	-	16/pc \$1525	20/pc \$1975
<b>GHIA CONVERTIBLE</b>	1957 - '68	-	15/pc \$1525	19/pc \$1975
	1969 - '74	-	16/pc \$1525	20/pc \$1975

**ADDITIONAL KITS FOR BUG AND GHIA**

<b>Trunk Kits</b>	\$590
<b>Wire Cover / Bug</b>	\$120
<b>Rear Seat Risers / Bug</b>	\$75
<b>4/pc Floor Mats / Bug</b>	\$250
<b>4/pc Floor Mats / Ghia</b>	\$300

**CARPET KITS FOR TYPE III**

<b>12/pc Front / All Years</b>	\$1600
<b>3/pc Rear Engine / Notchback &amp; Fastback</b>	\$675
<b>4/pc Cargo / Squareback</b>	\$620

**RUBBER MATS AND FIREWALL RUBBER**

*Bug Sedan Only*

<b>A. Full Firewall / 1950 - '59 Bug</b>	\$35
<b>B. Half Firewall / 1960 - '65 Bug</b>	\$35
<b>Half Firewall / 1966 - '70 Bug</b>	\$35
<b>C. 4/pc Floor Mats / 1956 - '59 Bug</b>	\$105
<b>D. 2/pc Floor Mats / 1960 - '67 Bug</b>	\$105
<b>2/pc Floor Mats / 1968 - '72 Bug</b>	\$125
<b>2/pc Floor Mats / 1973 - '79 Bug</b>	\$125
<b>TUNNEL ONLY / 1956 - '59 Bug</b>	\$90



**CHROME TRIM RINGS**

*(Installed at no charge with Squareweave carpet)*

- For Heater Outlet / 1956 - '60 Bug
  - Only for rectangular cutouts near the door opening
- \$50pr

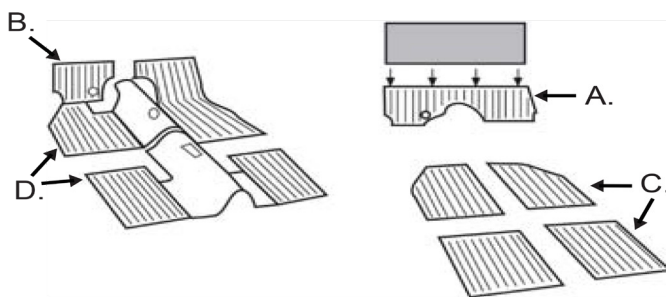

**GERMAN WOOL SQUAREWEAVE CARPET /// 100% WOOL. \$165/yd. 72" width**



Dark Grey  
316

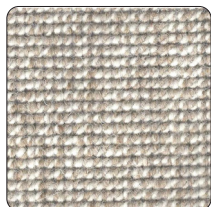

Oatmeal  
500



True Black  
315



Brown  
503

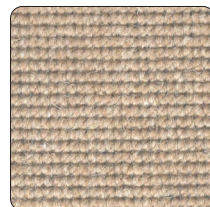

Tan  
400

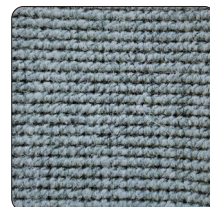

Blue  
107

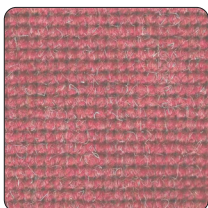

Red  
345



Black  
319

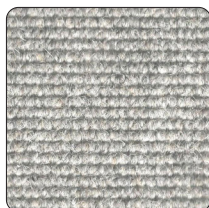

Light Grey  
701



Dark Blue  
318

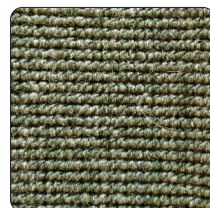

Dark Green  
320

Please call for fabric samples



## VINTAGE SERIES FABRICS

### BUS PLAIDS



Brown Plaid  
Green Contrast Thread

**Bus Plaids: Seat Covers** / Standard or Deluxe Insert Fronts, Deluxe Insert Rear Cover:  
Add \$400 to Standard Insert Seat Covers.  
**Panels** / Pricing Varies

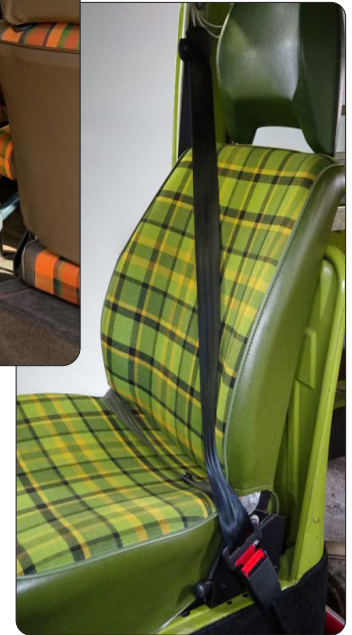

## GROUP A FABRICS

### PREMIUM NYLON TWEED

100% Nylon / 54" Wide

\$30/yd



Light Grey

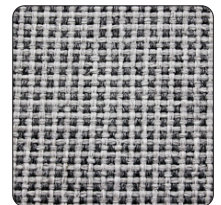

Grey Mix



Bone

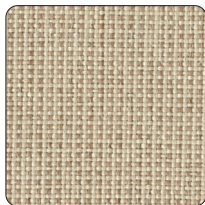

Natural



Beige



Oatmeal

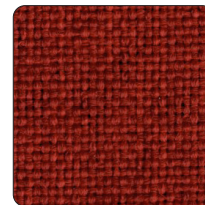

Deep Red

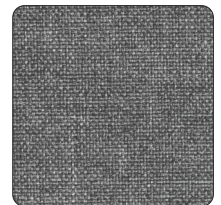

Charcoal

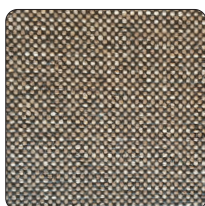

Sandstone



Mocha

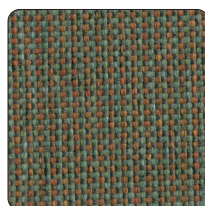

Wilderness



Blue Steel

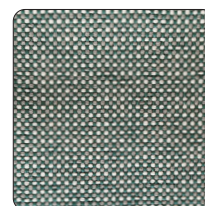

Black Marble



Black

## GTI / TARTAN PLAIDS

### GTI PLAIDS



Blue GTI Plaid



Red GTI Plaid



Tan/Red Plaid



Gray/Navy Plaid

**GTI Plaids: Seat Covers**  
**Standard or Deluxe Insert Fronts, Deluxe Insert Rear Cover** Add \$500 to Standard Insert Seat Covers  
**Panels** Add \$250 to 4/pc Panels



Please call for fabric samples



## ULTRA VINYL

### KINDIG RED ULTRA VINYL /// GROUP B



**KINDIG RED VINYL**

Featured in the "Little Sister Bug" as well as the "Back to Basics" '66 Bus and "Dave's New Toy". All featured on *Bitchin Rides*.

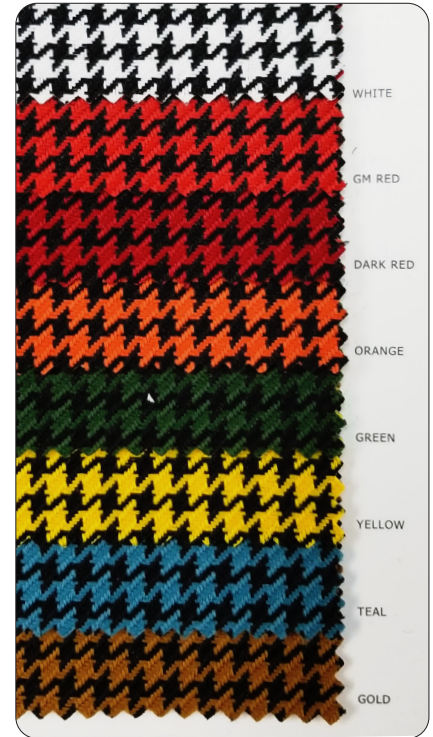

**HOUNDSTOOTH FABRIC**

Group B, plus 25%

### CALI ULTRA VINYL /// GROUP B

A great selection of Ultra Leather/Ultra Vinyl products. These are premium vinyls manufactured to look and feel like leather. Soft and luxurious, semi-smooth surface.

55" Wide

\$55/yd





## GROUP A VINYL

54" Wide / \$40yd



Brite White



XTR-610  
Cool Gray



XTR-609  
Dark Gray



XTR-614  
Graphite



XTR-601  
Black



Off White



XTR-615  
Buff



XTR-616  
Wheat



XTR-608  
Saddle



XTR-600  
Coffee



XTR-604  
Bright Red



XTR-606  
Wine



XTR-613  
Forest Green

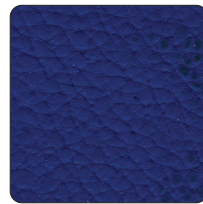

XTR-612  
Royal Blue

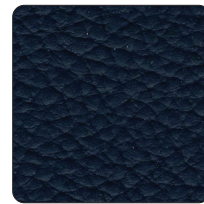

XTR-603  
Navy Blue

## SPECIALTY VINYL GROUP B

More Group B choices shown on our  
 Website at [sewfineproducts.com](http://sewfineproducts.com)

54" Wide

\$45/yd



Bay Window  
Orange



Tiger Lily

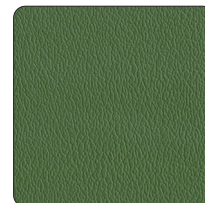

Bay Window  
Green



Kindig Red



OMG Green



Goldenrod

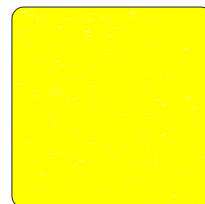

Yellow

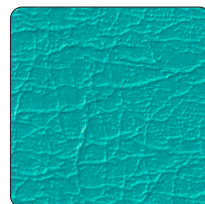

Turquoise

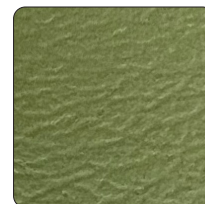

Sage



Seafoam

Please call for fabric samples



## VINTAGE VINYL GROUP B

Basketweave Seat Covers have SEWN pleats rather than the original Heat Seamed Embossing. Other colors available.



Black  
Basketweave

## HEADLINER VINYL

All Group A or B Fabrics and Vinyls can be used for Headliners, as well as these two colors below.

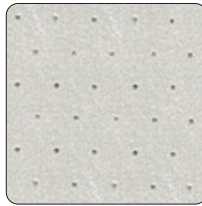

Off White  
Perforated Vinyl  
54" Wide / \$25yd  
Headliners Only



Satin Gray  
Non-Perforated Vinyl  
54" Wide / \$35yd

## SEAT BELTS

Available in Black, Red, Grey, Tan, Navy Blue, Orange, Brown, White, Dark Green, Turquoise, and Maroon.

<b>3 Point Retractable</b>	\$155/ea
<b>3 Point Non-Retractable</b>	\$85/ea
<b>2 Point Lap / 60"</b>	\$50/ea



## HAARTZ STAYFAST CANVAS

Standard Colors / 54" Wide / \$150yd



Black



Burgundy

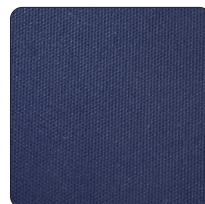

Navy

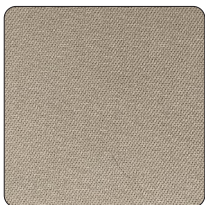

Tan



Brown



Grey

Hot Rod Colors / 54" Wide / \$170yd

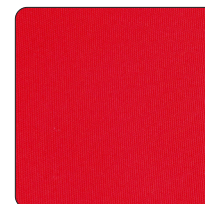

Red

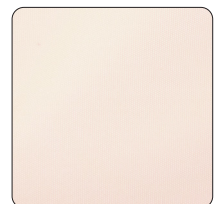

Oyster

## ORDERING INFORMATION

### TERMS & CONDITIONS

#### PAYMENTS:

Phone orders are accepted with Visa, Mastercard, or Discover Cards between the hours of 8:00AM to 5:00PM Monday through Friday (Mountain Standard Time). Any credit card issued outside the U.S. requires a copy of front and back of credit card with authorized signature signed again outside the card. Money orders in US funds also accepted.

#### SHIPPING:

In most cases, items are shipped UPS Ground. No COD orders accepted. Minimum shipping and handling fee is \$10.00. Shipping outside the U.S. varies; we look for the best rates available.

#### RETURNS:

*EACH ITEM IS CUSTOM MADE PER VEHICLE SO RETURNS CANNOT BE ACCEPTED.*

To be sure of choices before ordering, fabric and carpet samples are available upon request. It is imperative that we are aware of any vehicle modifications with order placement. Call for samples when matching is imperative. Returns for incorrect merchandise or product made in Sewfine's error will be accepted and corrected promptly. Requests must be made within 45 days of receipt of merchandise.

#### DAMAGE:

Freight damage must be claimed immediately. Save all damaged product and cartoning, and notify Sewfine immediately.

#### DISCLAIMER OF WARRANTIES

Slick Rides, Inc. dba Sewfine Interior Products ("Sewfine") implied, with respect to any product, and specifically disclaims without limitation, warranties for merchantability, non-infringement purpose. Sewfine's sole obligation and liability for product defects shall be, at Sewfine's option, to replace such defective product or refund to buyer the amount paid shall Sewfine's liability exceed the buyer's purchase price.

The foregoing remedy shall be subject to buyer's written notification of defective product within ninety (90) days of purchase. The foregoing remedy does not apply to products that have been subjected to misuse, neglect, accident or modification, occurs as a result of the failure of buyer to follow specific instructions.

In no event shall Sewfine be liable to the buyer or to any third party for any indirect, incidental, special, consequential, punitive or exemplary damages arising out of or relating to any product or service provided or to be provided by Sewfine, or the use or inability to use the same, even if Sewfine has been advised of the possibility of such damages.

Sewfine Interior Products is in no way affiliated with or sponsored by VWOA or VWAG. The VW logo and the marks VW, Volkswagen, Beetle, and Bug are registered Trade Marks of VWAG. The use of Volkswagen names and their model names are used in applications and descriptions for reference purposes only. Use of various companies names and product lines within this catalog exists only for descriptive and informational purposes and does not infer any direct connection between Sewfine Interior Products and these companies.

## INDEX

CONTENTS	PAGE
Armrests	3, 22, 27
Assist Straps	32
Button Kit	18
Carpet Insulation	37, 38, 43
Carpet / Bug	40 - 44
Carpet / Ghia	38
Carpet Samples	39, 45
Carpet / Type III	37
Convertible Parts	34 - 36
Convertible Tops & Headliners	34, 35
Door Panels / Bug	24 - 27
Door Panels / Ghia	23
Door Panels / Type III	28 - 29
EBrake Boots	42
Fabric Samples	46, 47, 48
Fender Beading	22
Foam Cushions	19
Headliners	30 - 31
Hidden Stitch Pleat Covers	16
Knebes Interior	3
Little Sister Panels & Seat Covers	27
Pillows	17
Plaids	46
Seat Back Panels	18
Seat Belts	50
Seat Covers	10 - 16
Sunroof Covers	32
Squareweave Carpets	44 - 45
Tabs for Seat Frames	18
Thing Interior	21
Trim Options	4 - 5
Type 34 Ghia	20
Tweed Samples	46
Upholstering Aids	18-19
Visors	33
Vinyl Samples	48, 49

## Sewfine Interior Products

2280 S Lipan St  
Denver, CO 80223



Where *Custom* has no limits...

720-287-2127

[sewfineproducts.com](http://sewfineproducts.com)

[sales@sewfineproducts.com](mailto:sales@sewfineproducts.com)

